

11 Engine

OM 314

Contents

Group 0: General

Special tools	004/1
General engine data – performance diagrams	010/1

Group 03: Engine housing, crank assembly

Exploded views	005/1
Removal, installation and inspection of flywheel	080/1
Replacement of starter ring gear	110/1
Removal and installation of pulley – crankshaft	205/1
Removal and installation of piston	300/1
Replacement of piston rings	320/1
Mounting of connecting rod	387/1
Removal of crankshaft	410/1
Installation of crankshaft	411/1
Mounting of crankshaft	467/1

Group 05: Timing

Exploded views	005/1
Adjustment of valve clearance (method 1 + 2)	070/1
Removal and installation of cylinder head cover	106/1
Removal of cylinder head	130/1
Installation of cylinder head	140/1
Removal and installation of valves	290/1
Machining of valve seats	300/1
Grinding of valves	320/1
Removal and installation of valve guides	350/1
Renewal of valve seat rings	380/1
Removal and installation of camshaft	560/1

Group 07: Injection system

Exploded views	005/1
Installation survey – injection pump	007/1
Test values for injection pump and governor	008/1
Adjustment of injection pump in relation to engine	050/1
Removal of injection pump	060/1
Installation of injection pump	061/1
Removal and installation of nozzle holder and protective sleeve	300/1
Inspection of injection nozzle	350/1
Disassembly and assembly of nozzle holder and injection nozzle	360/1



Group 13: Air compressor

Exploded view	005/1
Removal and disassembly of air compressor	150/1
Mounting and installation of air compressor	151/1

Group 18: Engine lubrication

Removal and installation of oil filter elements	100/1
Disassembly and assembly of oil filter carrier	110/1
Removal and installation of oil pump	200/1
Disassembly and assembly of oil pump	210/1

Group 20: Engine cooling

Exploded view	005/1
Removal and installation of water pump	100/1
Disassembly and assembly of water pump	130/1

0.11 Special tools

OM 314

Designation	Part number
Box/open end wrench	352 589 00 01 00
Special wrench	000 589 06 03 00
Special wrench for injection lines	000 589 07 03 00
Special wrench for injection lines SW 17	000 589 68 03 00
Special wrench for injection lines SW 19	346 589 00 03 00
Socket wrench	312 589 02 07 00
Pin spanner	321 589 00 07 00
Special wrench for protective sleeve	346 589 00 07 00
Socket for set screw	000 589 75 09 00
Impact/box wrench	001 589 43 09 00



0.11

Designation	Part number
Pin spanner	322 589 00 09 00
Valve adjusting wrench	321 589 00 11 00
Special wrench	000 589 01 13 00
Special wrench	346 589 00 13 00
Sleeve	312 589 01 14 00
Mandrel	110 589 02 15 00
Mandrel	321 589 00 15 00
Installation mandrel for valve seat rings	346 589 03 15 00
Mandrel	615 589 01 15 00
Internal measuring instrument	000 589 33 19 00
Dial gauge	001 589 53 21 00
Torque wrenches	
0– 60 Nm (0–6 kpm)	000 589 27 21 00
20–100 Nm (2–10 kpm)	000 589 64 21 00
80–300 Nm (8–30 kpm)	001 589 39 21 01
260–750 Nm (26–75 kpm)	000 589 39 21 00

0.11 Special tools

Designation	Part number
Angle of rotation tool	403 589 01 21 00
Container for adjusting injection pump	000 589 05 23 00
Slip gauge 0.03– 1.0 mm	000 589 13 23 00
Pipe with nipple	636 589 02 23 00
Nozzle tester	000 589 14 27 00
Heli-coil tool box	
M6, M8, M10, M12, M14	000 589 03 28 00
M8 × 1, M12 × 1,5, M14 × 1,5, M14 × 1,25	000 589 04 28 00
M15 × 2	000 589 05 28 00
M16 × 1,5	000 589 06 28 00
M18 × 1,5	000 589 07 28 00
M24 × 1,5	000 589 08 28 00
M26 × 1,5	000 589 09 28 00
M16	000 589 10 28 00
M30 × 1,5	000 589 11 28 00
Clamping strap	000 589 38 31 00
Internal puller	000 589 28 33 00
Internal puller	000 589 29 33 00
Mounting for nozzle holder	403 589 00 31 00



0.11

Designation	Part number
Internal puller	000 589 26 33 00
Countersupport	000 589 33 33 00
Countersupport	000 589 34 33 00
Puller	000 589 88 33 00
Puller	312 589 07 33 00
Puller for nozzle holder	352 589 00 33 00
Puller	355 589 00 33 00
Mandrel	321 589 01 35 00
Pliers	312 589 01 37 00
Piston ring pliers	000 589 37 37 00
Pliers	321 589 00 37 00
Clamping strap	321 589 01 37 00
Mandrel with bushings	352 589 00 43 00

0.11 Special tools

Designation	Part number
Remover and installer	352 589 01 43 00
Bushing	312 589 00 50 00
Reamer 9 mm dia.	000 589 10 53 00
Reamer 10 mm dia.	000 589 11 53 00
Adjustable reamer	000 589 18 53 00
Drop hardness tester	000 589 20 61 00
Thrust piece	321 589 00 63 00
Undercooling box	346 589 00 63 00
Impact tool	355 589 01 63 00
Holder for dial gauge	403 589 04 63 00
Bosch nozzle cleaner	000 589 00 68 00
Ring seat machining tool	000 589 10 69 00
Valve seat machining tool for trucks	000 589 16 69 00



0.11

Workshop equipment

Designation	Partnumber
Internal measuring instrument 10– 18 mm dia. 18– 35 mm dia. 35– 60 mm dia. 50– 100 mm dia.	conventional
Micrometer 0– 25 mm dia. 25– 50 mm dia. 50– 75 mm dia. 75–100 mm dia.	conventional
Swing guide	conventional
Valve fixture for holding cylinder head	conventional

0.11 General engine data – output diagrams

OM 314

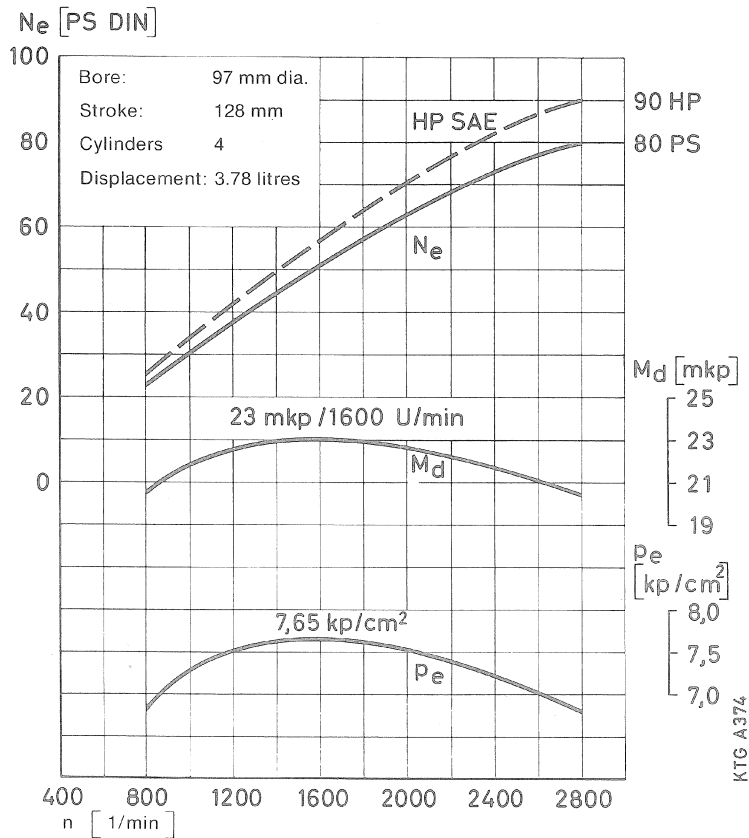

OM 314, 80 HP

Engine output ¹⁾ according to DIN	80 HP at 2800/min	Compression pressure at 150–200/min	min. 20 bar (kpcm ²)
Engine output according to SAE	88 HP at 2800/min	Opening pressure of injection nozzles	new 200 bar + 10 (kp/cm ²) used min. 180 bar (kp/cm ²)
Max. torque	266 Nm (23 kpm) at 1600/min	Min. oil pressure at max. speed	2.5 bar (kp/cm ²)
Nominal speed	2800/min	Min. oil pressure at idling speed	0.5 bar (kp/cm ²)
Number of cylinders	4	Engine Oil capacity	up to engine no. 314.910...020 055 max. approx 6 l min. approx. 4.5 l
Bore	97 mm dia.	Oil pan	starting engine no. 314.910...020 056 max. approx. 8 l min. approx. 5 l
Stroke	128 mm	Oil filter	approx. 2 l
Total displacement	3780 cc		
Operation	Diesel 4-stroke		
Begin of delivery	21° BTDC		
Compression ratio	17.0		
Firing order	1–3–4–2		

¹⁾ The indicated output in HP according to DIN 70020 is effectively available at clutch for driving the vehicle, since all auxiliary requirements have already been deducted.



Transporters volume 1



Engines volume 2 – supplement 2 – revision – December 1977

0.11

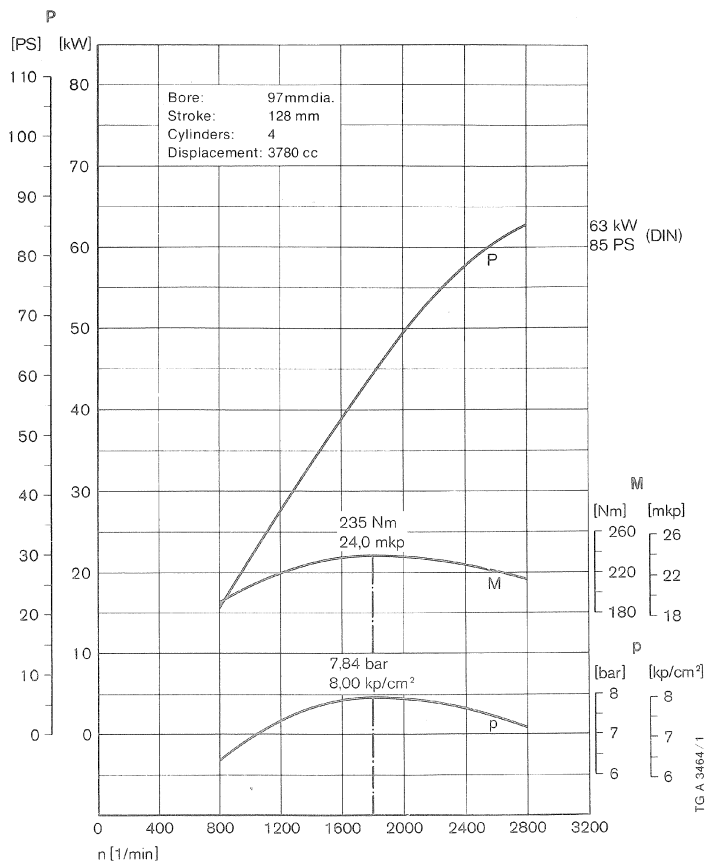

OM 314, 85 HP

Engine output ¹⁾ according to DIN	63 KW at 2800/min 85 HP at 2800/min	Compression pressure at 150–200/min	min. 20 bar (kp/cm ²)
Engine output according to SAE	80 net bhp at 2800/min	Opening pressure of injection nozzles	new used
Max. torque	235 Nm (24 kpm) at 1800/min 169.5 lb-ft at 1900/min	Min. oil pressure at max. speed	200 bar + 10 (kp/cm ²) min. 180 bar (kp/cm ²)
Nominal speed	2800/min	Min. oil pressure at idling speed	2.5 bar (kp/cm ²) 0.5 bar (kp/cm ²)
Number of cylinders	4	Engine Oil capacity	up to engine end no. 155 807 max. 8 l min. 5 l
Bore	97 mm dia.	Oil pan	starting engine end no. 155 808 up to engine end no. 217 859 max. 9 l min. 6.5 l
Stroke	128 mm		starting engine end no. 217 860 max. 9.5 l min. 6.5 l
Total displacement	3780 cc		
Operation	Diesel 4-stroke		
Begin of delivery	15° BTDC		
Compression ratio	17.0		
Firing order	1–3–4–2		

¹⁾ The indicated output in HP and KW according to DIN 70020 is effectively available at clutch for driving the vehicle, since all auxiliary requirements have already been deducted.

Oil filter

2 l

03.11 Exploded views

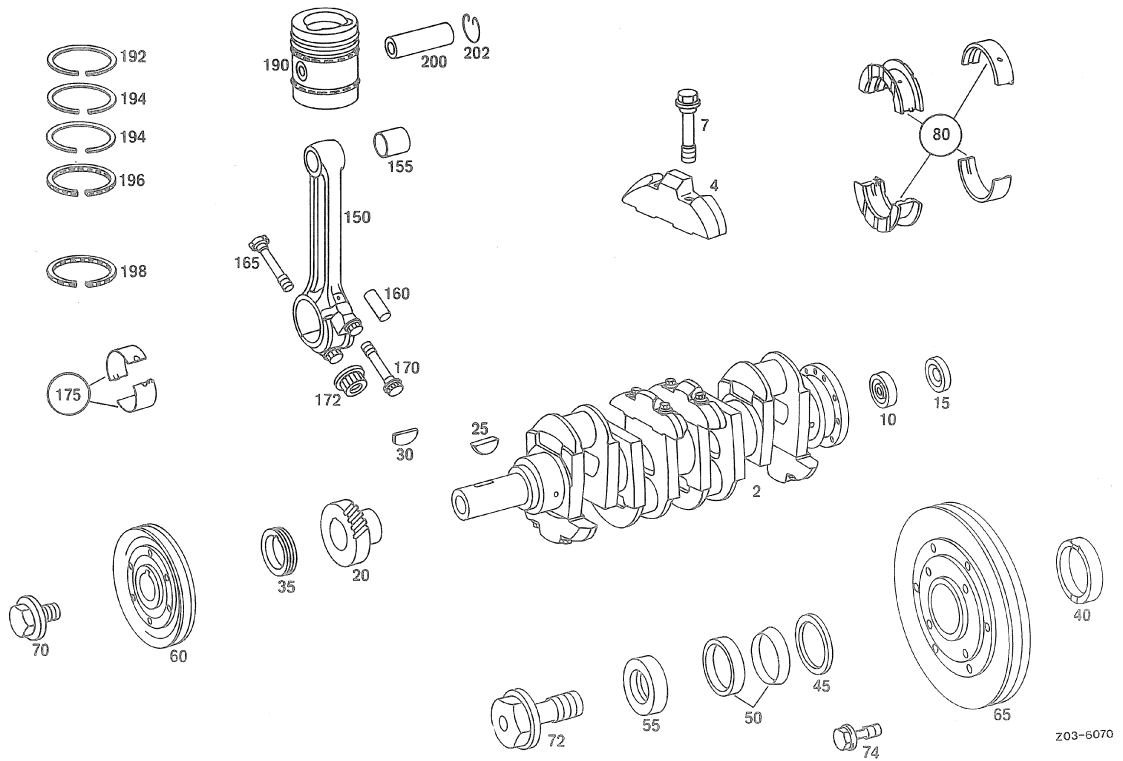

Crank assembly

2	Crankshaft	50	Clamping element	165	Screw
4	Counterweight	55	Thrust ring	170	Screw
7	Screw	60	Pulley	172	Nut
10	Radial ball bearing	65	Pulley	175	Repair kit connecting rod bearings
15	Closing ring	70	Screw	190	Piston
20	Crankshaft gear	72	Screw	192	Piston ring
25	Woodruff key	74	Screw	194	Piston ring
30	Woodruff key	80	Repair kit crankshaft bearings	195	Piston ring
35	Adapter	150	Connecting rod	198	Piston ring
40	Adapter	155	Connecting rod bushing	200	Piston pin
45	Spacing ring	160	Cyl. pin	202	Circlip

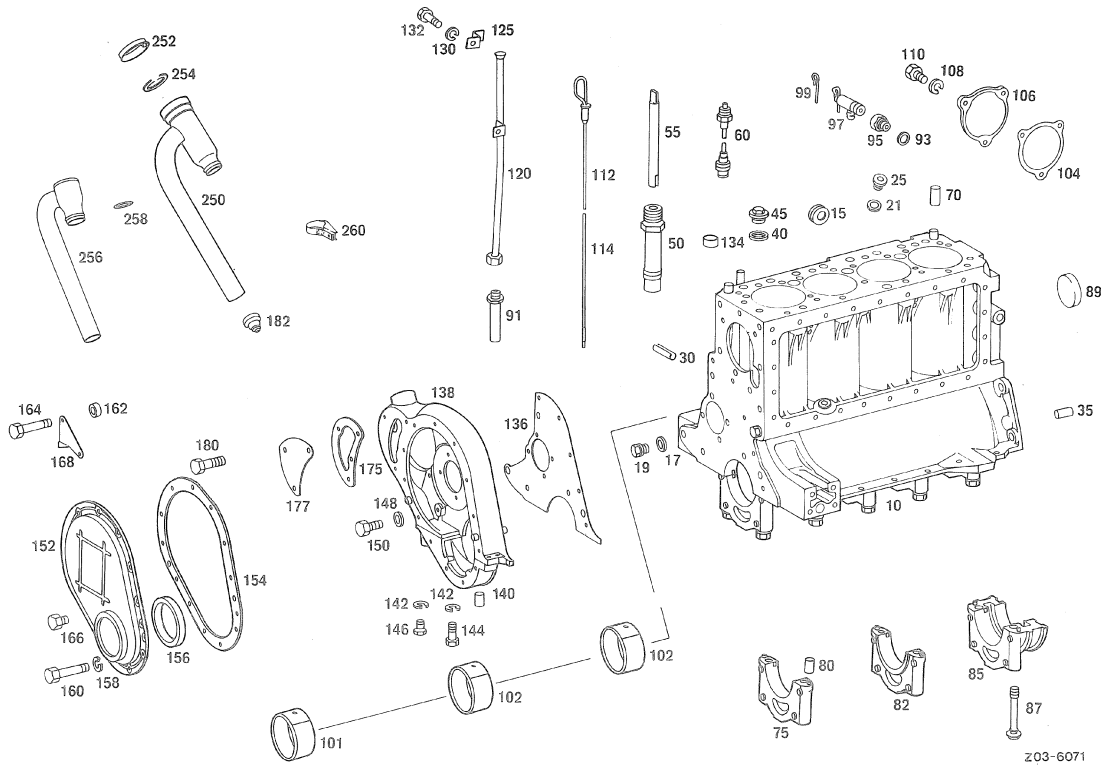

Cylinder crankcase

- 10 Crankcase
- 15 Closing screw
- 17 Sealing ring
- 19 Closing screw
- 21 Sealing ring
- 25 Closing screw
- 30 Sleeve
- 35 Set pin
- 40 Sealing ring
- 45 Closing screw
- 50 Distributor
- 55 Shaft
- 60 Shaft
- 70 Cyl. pin
- 75 Bearing cap
- 80 Cyl. pin
- 82 Bearing cap
- 85 Bearing cap
- 87 Screw
- 89 Closing plug
- 91 Guide tube
- 93 Sealing ring

- 95 Connection
- 97 Valve
- 99 Spring
- 101 Camshaft bearing
- 102 Camshaft bearing
- 104 Gasket
- 106 Flange
- 108 Snap ring
- 110 Screw
- 112 Oil dipstick
- 114 Oil dipstick
- 120 Guide tube
- 125 Holder
- 130 Snap ring
- 132 Screw
- 134 Closing cover
- 136 Gasket
- 138 Timing housing
- 140 Set pin
- 142 Snap ring
- 144 Screw
- 146 Screw

- 148 Shim
- 150 Screw
- 152 Cover
- 154 Gasket
- 156 Sealing ring
- 158 Snap ring
- 160 Screw
- 162 Spacing ring
- 164 Screw
- 166 Screw
- 168 Indicator
- 175 Gasket
- 177 Cover
- 180 Screw
- 182 Closing member
- 250 Oil filler neck
- 252 Cover
- 254 Gasket
- 256 Breather pipe
- 258 Sealing ring
- 260 Holder

03.11 Removal, installation and inspection of flywheel

OM 314

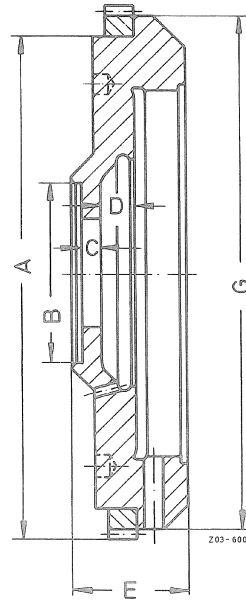

Data

	up to engine end no. 145 136	starting engine end no. 145 137
Dia. "A" for starter ring gear	<u>335.530</u> 335.390	<u>335.530</u> 335.390
Dia "B" for mounting crankshaft flange	<u>130.040</u> 130.000	<u>130.040</u> 130.000
Thickness "C" of fastening flange	15.0	<u>15.0</u> 15.1
Distance "D" between clutch surface and fastening flange of flywheel	24.0	23.5
Perm. material removal on clutch surface for repairs	1.0	1.0
Total width of flywheel dimension "E"	76.5	80
Depth between contact surfaces of clutch and flywheel	33.5	<u>38.5</u> 38.6
Flywheel OD "G"	<u>366.0</u> 365.7	<u>366.0</u> 365.7
Perm. non-parallel alignment (measured at 323 mm dia.)	max. 0.1	max. 0.1
Perm. radial runout of flywheel measured at dia. for starter ring gear	0.05	0.05



03.11

Tightening torques in Nm (kpm)

	SW 19	100 (10)
Flywheel attachment	SW 22	Initial torque 30+10 (3+1) final torque 90°+20°
SW 22 can be used again up to max. shank length of		26.3 mm

Special tools

Torque wrench 20–100 Nm (2–10 kpm)	000 589 64 21 00
Torque wrench 80–300 Nm (8–30 kpm)	001 589 39 21 01
Angle of rotation tool	403 589 01 21 00

Removal

1 Unscrew fastening screws of flywheel.

2 Loosen flywheel from crankshaft flange by means of a light blow with a plastic hammer and remove flywheel in downward direction.

Note: No marking of flywheel prior to removal is required, since the eight fastening screws are offset in relation to each other and wrong assembly is therefore impossible.

3 Clean flywheel and check for damage.

Note: If there are cracks, burned or rough spots, equalize flywheel by regrinding or remachining. Make sure that the fastening surface of the clutch is ground down by the same dimension, so that the distance between the fastening surface of the clutch and of the contact surface of the flywheel remains the same.

Do not exceed permissible material allowance.

4 Check starter ring gear.

03.11 Removal, installation and inspection of flywheel

Installation

- 1 Check elongation of fastening screws.

Note: Necked-down screws may be used again and again until their max. length is attained.

- 2 Place flywheel on crankshaft flange.
- 3 Turn flywheel on flange of crankshaft until all the bores and threaded holes are in alignment.
- 4 Lubricate all fastening screws on thread and supporting surface, and screw down.
- 5 Apply torque wrench 000 589 64 21 00 and socket to tighten fastening screws crosswise to specified initial torque. Continue tightening screws crosswise with angle of rotation tool 403 589 01 21 00 to specified angle of rotation.

Note: For SW 19 screws, use torque wrench 0001 589 39 21 01 only.

- 6 Measure vertical and lateral runout of flywheel.



03.11 Replacement of starter ring gear (flywheel removed)

OM 314

Data

	up to engine end no. 145 136	starting engine end no. 145 137
Dia. of ring gear mounting surface	<u>335.530</u> 335.390	<u>335.530</u> 335.390
ID of ring gear	<u>335.140</u> 335.000	<u>334.830</u> 334.690
Overlap of ring gear	0.25–0.53	0.56–0.84
Perm. lateral runout of mounted starter ring gear	0.5	0.5
Starter ring gear mounted at a temperature of	180–230° C	250–280° C

Replacement of starter ring gear

1 Quickly heat starter ring gear with welding torch and remove.

2 Heat new ring gear and fit.

Note: Force ring gear up to contact surface of flywheel.

3 Do not exceed max. lateral runout of ring gear after mounting.

Note: Grease ring gear prior to operation.



03.11 Removal and installation of pulley – crankshaft

OM 314

Tightening torques in Nm (kpm)

Pulley to crankshaft	500–550 (50-55)
----------------------	-----------------

Special tools

Impact-box wrench	001 589 43 09 00
Torque wrench 260–750 Nm (26–75 kpm)	000 589 39 21 00
Puller	000 589 88 33 00
Puller with thrust piece	355 589 00 33 00
Thrust piece	321 589 00 63 00

Removal

1 Remove V-belt.

2 Loosen central screw from crankshaft by means of impact-box wrench 001 589 43 09 00. Take off screw.

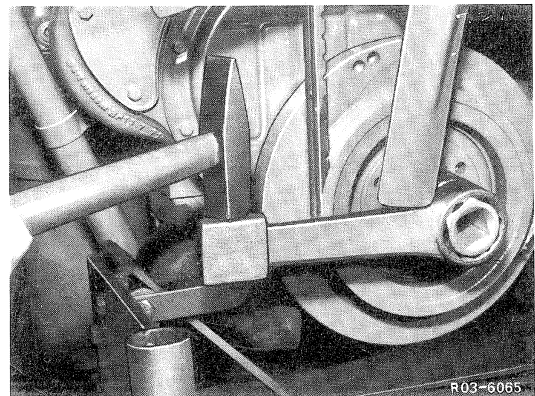

03.11

3 Pull pulley from crankshaft by means of puller and thrust piece 355 589 00 33 00 or with puller 000 589 88 33 00 and thrust piece 321 589 00 63 00.

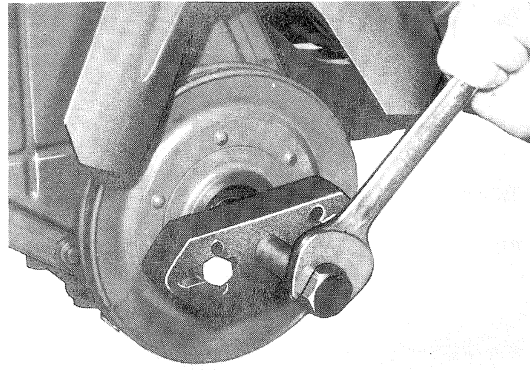

R 03-6031

Note: If a forward pto is installed, loosen pulley by means of a blow with a plastic hammer against pulley hub. No puller will be required.

4 Remove clamping elements, with forward pto installed, from crankshaft.

03.11 Removal and installation of pulley-crankshaft

Installation

1 With forward pto, mount tensioning elements in sequence a, b, c, d

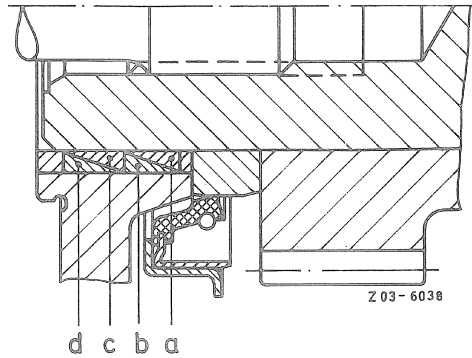

or starting engine end no. 057 600, slip-on pulley first and then install tensioning elements.

2 On standard version, heat pulley to approx. 80°C and mount on crankshaft.

Note: Make sure that the woodruff key enters groove of pulley.

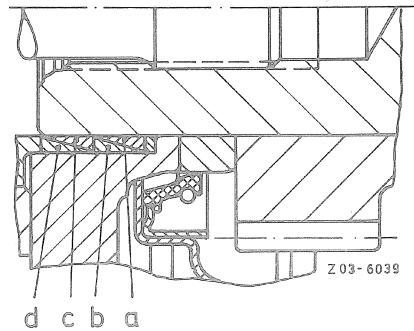

3 Screw central screws into crankshaft and tighten with socket 001 589 43 09 02 and torque wrench 000 589 39 21 00.

Note: Do not tighten central screw with impact screwdriver.

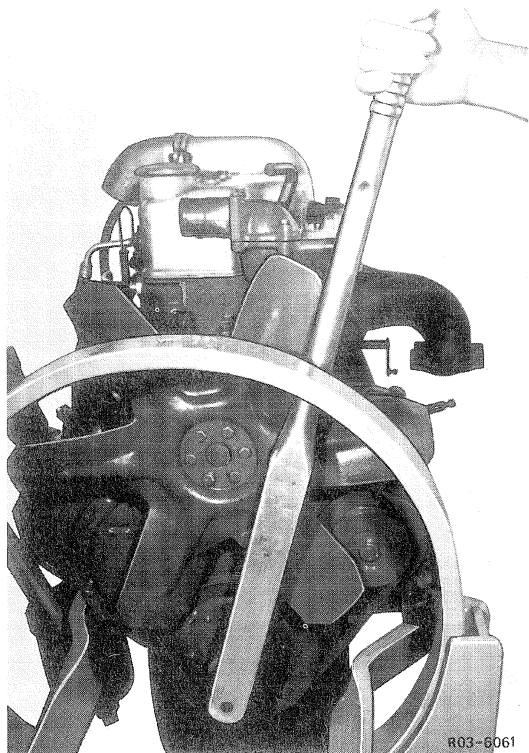

03.11 Removal and installation of piston (cyl. head and oil pan removed)

OM 314

Data

Repair stages	Cylinder bore	Total height – cyl. crankcase	Piston dia.	Compression height (central piston pin – piston crown)
Normal	97.010		96.91	
	96.990		96.89	
Normal I	97.085	359.10	96.99	65.26
	97.065	359.00	96.97	65.20
Normal II	97.135		97.04	
	97.115		97.02	
Rep. stage I	97.510	358.70	97.41	64.86
	97.490	358.60	97.39	64.80
Rep. stage II	98.010	358.50	97.91	64.66
	97.990	358.40	97.89	64.60
Rep. stage III	98.510	358.25	98.41	64.41
	98.490	358.15	98.39	64.35

When refinishing to next repair stage be sure to drill 250 mm down.

Perm. difference in weight within one engine	max. 20 g
Piston clearance on piston shaft	0.10–0.11
Connection rod bearing value	0.050–0.095
Connecting rod bearing axial	0.100–0.400
Piston clearance from upper edge of crankcase	Piston may stand back = – 0.07
	Piston may stand out = + max. 0.30
Perm. out-of-round of cylinder bore	0.01
Perm. conicity of cylinder bore	0.01
Perm. deviation of cylinder bores in vertical relation to crankshaft axis for 200 mm length	0.04
Roughness of cylinder bores	0.003 à 0.005
Waviness of cylinder bores	maxi. 50% roughness

Tightening torques in Nm (kpm)

Connecting rod bolts	Initial torque 100 + 10 (10 + 1) Final torque 90° angle of rotation
M 14 can be used again up to max. shank length of	82.5 mm
M 15 can be used again up to max. shaft length of	61.5 mm



03.11

Special tools

Torque wrench 80–300 Nm (8–30 kpm)	001 589 39 21 01
Angle of rotation tool	403 589 01 21 00
Clamping strap	000 589 38 31 00

Note: Complete pistons in 4-ring and 5-ring version are interchangeable, also individually.

Removal

1 Carefully remove combustion residue above top land in cylinder liner with a scraper to prevent damage to piston rings.

2 Unscrew connecting rod bearing cap from connecting rod and remove.

Note: make sure that associated bearing caps and connecting rods are marked.

3 Push out connecting rod with piston from below.

4 Lift piston out of cylinder crankcase.

5 Clamp connecting rod with piston into vise (use soft vise jaws).

6 Remove piston pin lock, push out piston pin and remove piston from connecting rod.

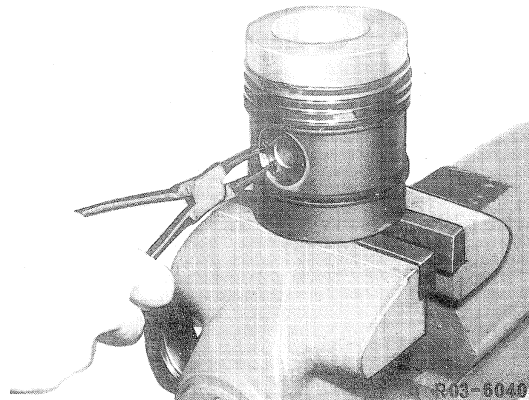
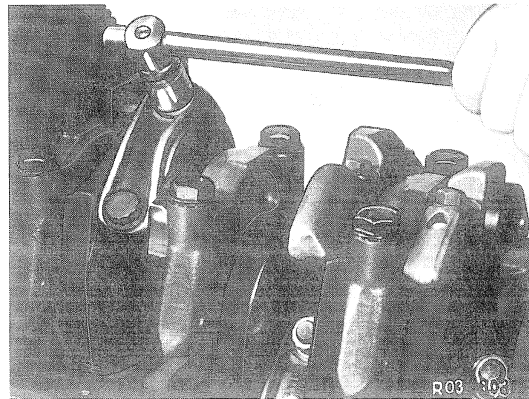

Installation

Note: If pistons with reduced compression height are installed, refinish parting surface of cylinder crankcase by the difference in compression height of piston.

03.11 Removal and installation of piston (cylinder head and oil pan removed)

1 Introduce connecting rod into piston so that the longer end of the diagonally split connection rod bearing is pointing to the right (arrow points to the left) and the arrow on the piston ground points forward in driving direction.

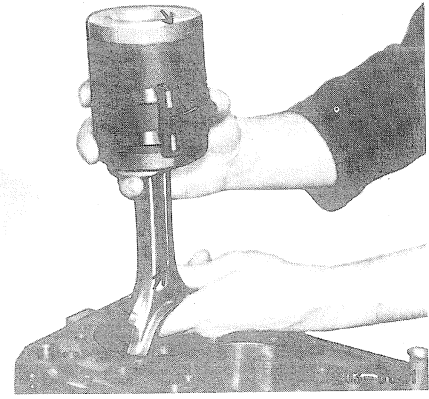

2 Introduce piston pin and secure with locking rings.

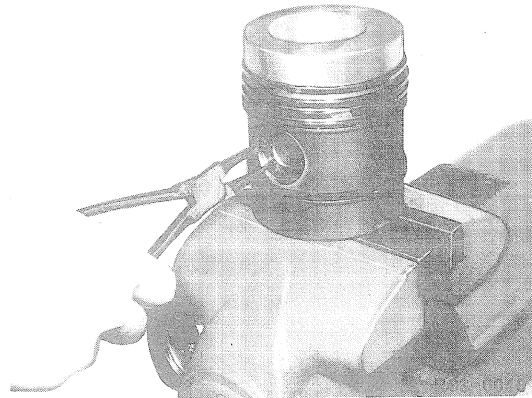

3 Moisten piston with engine oil. Displace piston ring gaps in sequence by 180°. Slide clamping strap 000 589 38 31 00 loosely over piston rings and tighten to OD of piston, so that the sleeve can barely be moved.

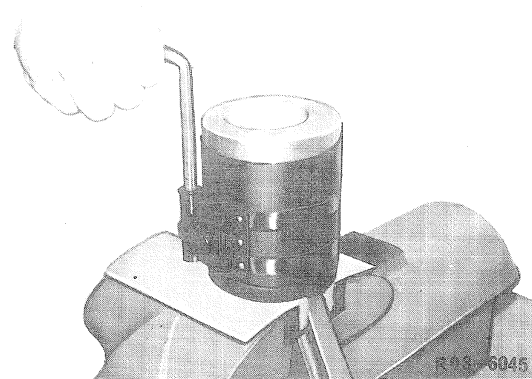

4 Insert connecting rod bearing shell into connecting rod. Make sure that lug enters groove of connecting rod. Coat running surface with oil.

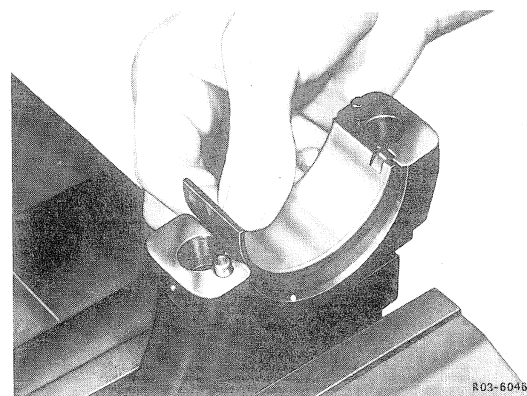

03.11

5 Introduce piston into cylinder crankcase with arrow pointing in driving direction.

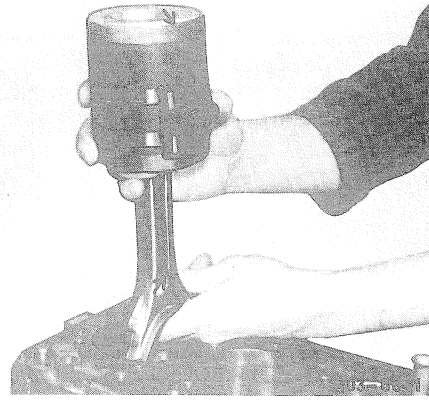

6 Keep forcing-in piston until connecting rod bearing rests against crankpin of crankshaft.

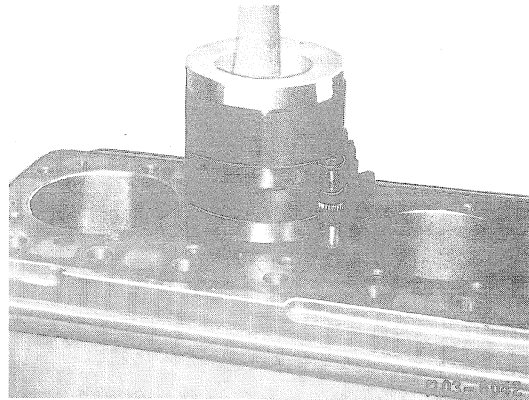

7 Insert connecting rod bearing shell into connecting rod bearing cap. Make sure that the lug is seated in connecting rod bearing cap groove. Coat running surface of connecting rod bearing shell with oil.

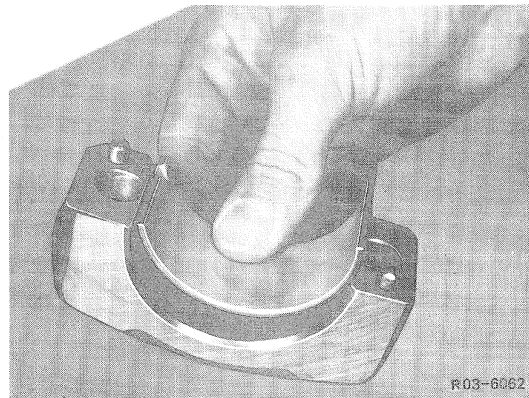

8 Position bearing cap on connecting rod and screw-in connecting rod bolts manually.

9 Screw angle of rotation tool 403 589 01 21 00 to extension for socket wrench.

10 Tighten bolts with torque wrench 001 589 39 21 01 alternately into steps to $100 + 10 \text{ Nm}$ ($10 - 1 \text{ kpm}$) and continue tightening according to angle of rotation tool by $90^\circ + 20^\circ$.

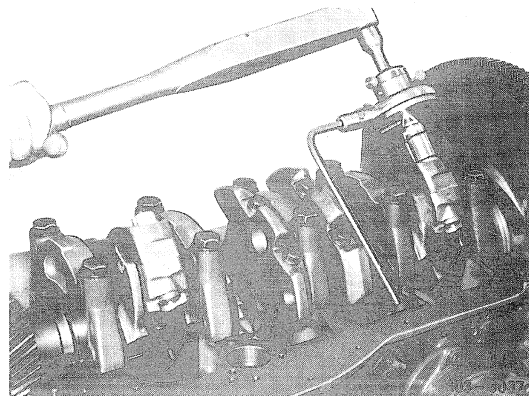

03.11 Replacing piston rings (piston removed)

OM 314

Data

5-ring piston

Groove	Piston ring designation	Width of groove	Side clearance	Gap clearance
I	Keystone ring	$3^{+0.030}_{+0.015}$	0.044–0.080	0.35–0.55
II	Modified tapered compression ring	$3^{+0.060}_{+0.045}$	0.055–0.082	0.35–0.55
III	Modified tapered compression ring	$3^{+0.060}_{+0.045}$	0.055–0.082	0.35–0.55
IV	Chamfered ring	$5.5^{+0.040}_{+0.025}$	0.035–0.062	0.25–0.40
V	Narrow groove ring	$5.5^{+0.030}_{+0.015}$	0.025–0.052	0.25–0.40

4-ring piston

Groove	Piston ring designation	Width of groove	Side clearance	Gap clearance
I	Keystone ring	3	0.044–0.080	0.35–0.55
II	Tapered compression ring	$3^{+0.060}_{+0.040}$	0.055–0.082	0.35–0.55
III	Tapered compression ring	$3^{+0.060}_{+0.040}$	0.055–0.082	0.35–0.55
IV	Chamfered ring with expanding spring	$5.5^{+0.040}_{+0.020}$	0.035–0.062	0.25–0.40

Special tools

Piston ring pliers

000 589 37 37 00

Replacing piston rings

- 1 Set piston ring pliers 000 589 37 37 00 with adjusting screw to approx. 98 mm dia.
- 2 This adjustment permits removal and installation of piston rings.

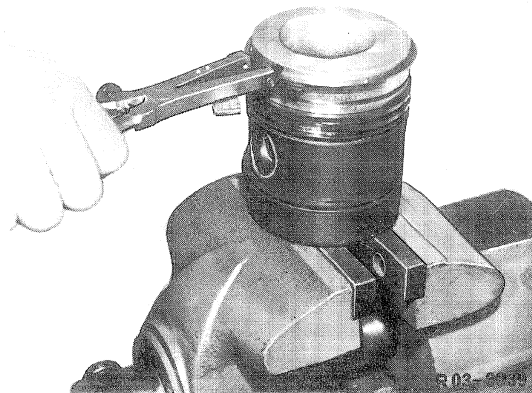

Transporters volume 1



Engines volume 2 – supplement 2 – revision – December 1977

03.11 Mounting of connecting rod

OM 314

Data

Connecting rod bearing shells

Repair stage	Connecting rod bearing	
	Bearing bore in installed condition	Wall thickness for bearing shells ready for installation
Normal	59.985	2.512–2.522
	59.965	
Normal I	59.835	2.587–2.597
	59.815	
Rep. stage I	59.835	2.587–2.597
	59.815	
Rep. stage II	59.585	2.712–2.722
	59.565	
Rep. stage III	59.335	2.837–2.847
	59.315	
Rep. stage IV	59.085	2.962–2.972
	59.065	
Radial play of crankshaft main bearing journal		0.050–0.090
Axial play of crankshaft (fitted bearing)		0.190–0.290



03.11

Connecting rod

Basic bore in connecting rod		<u>65.019</u>
		65.000
Perm. conicity of basic bore for connecting rod bushing		0.005
Overlap of connecting rod bearing shells		0.04–0.07
Radial play of crankpins		0.050–0.095
Axial play of crankpins		0.100–0.400
Perm. deviation of parallel alignment of connecting rods		0.03
Perm. twist, at distance of 50 mm		0.025
Distance from center of crankshaft to center of piston pin bore		<u>230.05</u>
		230.00
Perm. difference in weight of connecting rods within one engine		20 g
	Normal	<u>39.225</u>
		39.000
Basic bore for connecting rod bushing	Rep. stage I	<u>39.225</u>
		39.200
	Rep. stage II	<u>39.525</u>
		39.500
Width of connecting rod at	connecting rod eye	<u>37.830</u>
		37.730
	piston pin eye	<u>35.6</u>
		35.5

Connecting rod bushing

	Normal	<u>39.075</u>
		39.045
Connecting rod bushing OD	Rep. stage I	<u>39.275</u>
		39.245
	Rep. stage II	<u>39.575</u>
		39.545
Overlap of connecting rod bushing in connecting rod		0.020–0.075
Connecting rod bushing ID		<u>36.040</u>
		36.030

03.11 Mounting of connecting rod

Tightening torques in Nm (kpm)

Connecting rod bolts M 14 and M 15	Initial torque 100 + 10 (10 + 1)	Final torque 90° + 20°
Connecting rod bolts M 12	90 (9)	
Max. shank allongation of screws M 14	82.5 mm	
Max. shank allongation of screws M 15	61.5 mm	

Special tools

Dial gauge	000 589 53 21 00
Torque wrench 20 – 100 Nm (2 – 10 kpm)	000 589 64 21 00
Angle of rotation tool	403 589 01 21 00

Mounting of connecting rod

Note: The bearing shells for the connecting rod bearing of all repair stages are supplied ex factory ready for installation. No refinishing of bearings is permitted.

- 1 Clean bearing surfaces in connecting rod and bearing caps with chamois leather only.
- 2 Insert bearing shell halves into connecting rods and bearing caps in correct sequence. Make sure that the securing plugs of the bearing shells are perfectly seated in grooves of basic bore.
- 3 Place bearing cap with bearing shell on connecting rod, making sure of pertinent identification (numerals must be on one side) of mating bearings.
- 4 Tighten fastening screws with torque wrench 000 589 64 21 00 to specified torque and then continue tightening with angle of rotation tool 403 589 01 21 00 as specified.

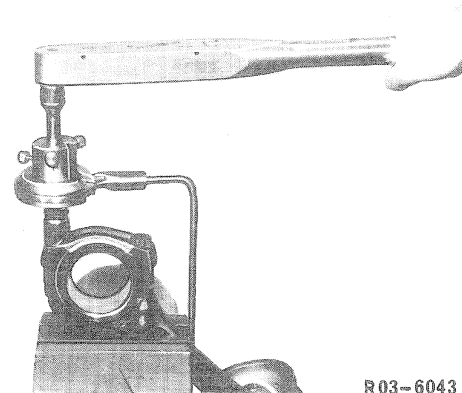
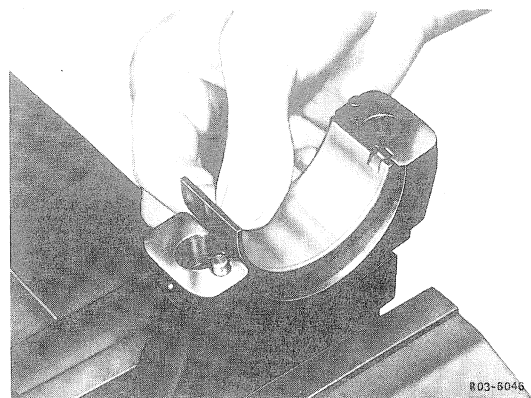

03.11

5 Set internal measuring tool 50–100 mm dia. and dial gauge 000 589 53 21 00 with micrometer 50–75 mm dia. to zero dimension of connecting rod bearing bore.

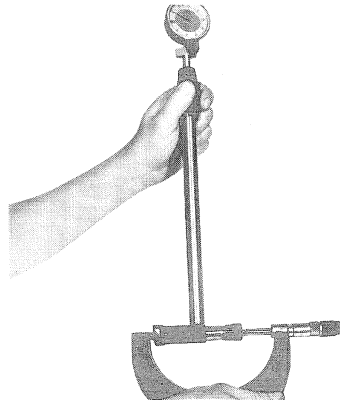

R03-6014

6 Measure connecting rod bearing bore with pertinently set internal measuring device 50–100 mm dia. at three points (vertically and each approx. 30° from top and bottom of parting surfaces).

Note: The values named in tables must be observed.

7 Unscrew bearing caps again.

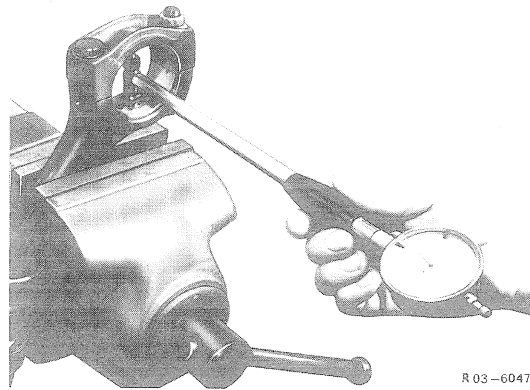

R03-6047

03.11 Removal of crankshaft

OM 314

Special tools

Internal puller	000 589 26 33 00
Countersupport	000 589 33 33 00
Puller	312 589 07 33 00
Remover and installer	352 589 01 43 00

Initial jobs

- Remove oil pan
- Remove vibration damper
- Remove oil pump
- Remove nozzles

Removing crankshaft

1 Unscrew timing housing cover. Check radial sealing ring for damage and wear and replace with remover and installer 352 589 01 43 00, if required.

2 Unscrew timing housing lower half and remove.

3 Unscrew connecting rod bearing bolts in sequence. Loosen bearing caps with a light plastic hammer and remove.

Note: Make sure that bearing caps and connecting rods are marked in relation to each other.

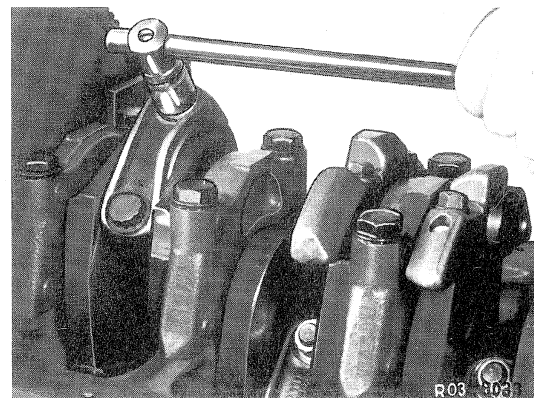
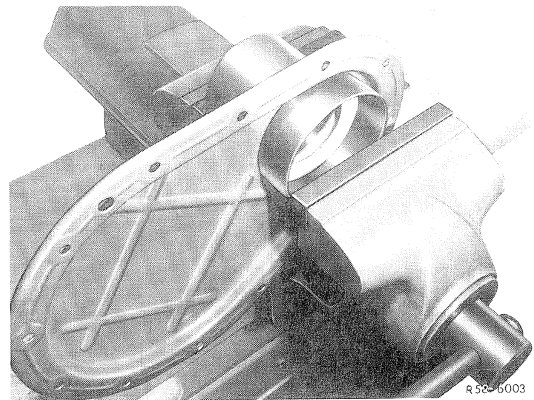

03.11

- 4 Push back connecting rod with piston.
- 5 Unscrew bolts of crankshaft bearing caps. Loosen bearing cap with a light plastic hammer and remove.

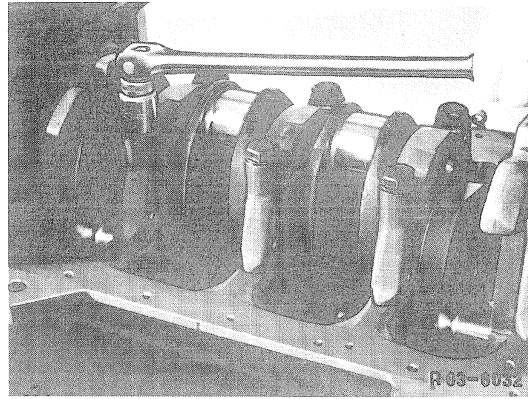

- 6 Lift crankshaft with flywheel out of crankcase.
- 7 Remove bearing shell halves from crankcase and connecting rods.
- 8 Check all parts for damage and wear.
- 9 Pull damaged radial ball bearing out of crankshaft by means of internal puller 000 589 26 33 00 and countersupport 000 589 33 33 00.

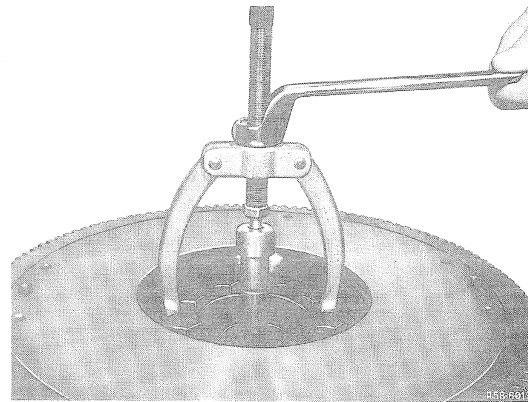

- 10 Remove crankshaft gear from crankshaft by means of puller 312 589 07 33 00.

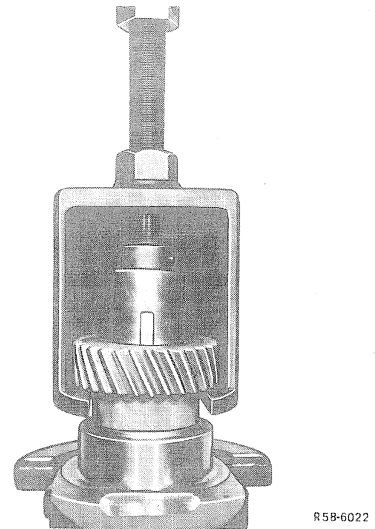

03.11 Installation of crankshaft

OM 314

Data

End play of crankshaft	0.19–0.29
------------------------	-----------

Tightening torques in Nm (kpm)

Connecting rod bolts		Initial torque 100 + 10 (10 + 1) Final torque 90° + 20°
Max. elongation of connecting rod bolts		82.5 or 75.5
Main bearing cap up to engine end no. 000 820	M 14	120 (12)
starting from above engine no.	M-14	140 (14)
	M 15	Initial torque 50 + 10 (5 + 1) Final torque 90° + 20°
Max. elongation of main bearing bolts		123.0
Hardness of crankshaft journals and crankpins (Rockwell hardness)		56 ± 3

Special tools

Torque wrench 20–100 Nm (2–10 kpm)	000 589 64 21 00
Torque wrench 80–300 Nm (8–30 kpm)	001 589 39 21 01
Dial gauge	001 589 53 21 00
Holder for dial gauge	363 589 02 21 00
Angle of rotation tool	403 589 01 21 00
Bushing	312 589 00 50 00
Drop hardness tester	000 589 20 61 00



03.11

1 Blow out oil ducts of crankcase with compressed air from pump end.

2 Thoroughly clean oil ducts of crankshaft with a wire brush and blow out with compressed air. Clean crankshaft bearing journals, bearing shell halves and bearing seats with chamois leather.

3 Check hardness of crankshaft journals and crankpins with sclerograph drop hardness tester 000 589 20 61 00.

Note: A conversion table is enclosed with hardness tester.

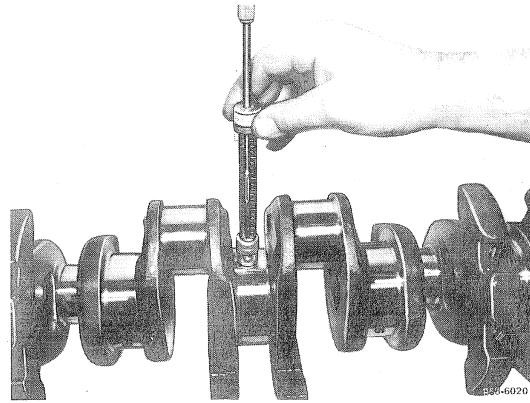

4 Mount crankshaft gear with bushing 312 589 00 50 00 on crankshaft.

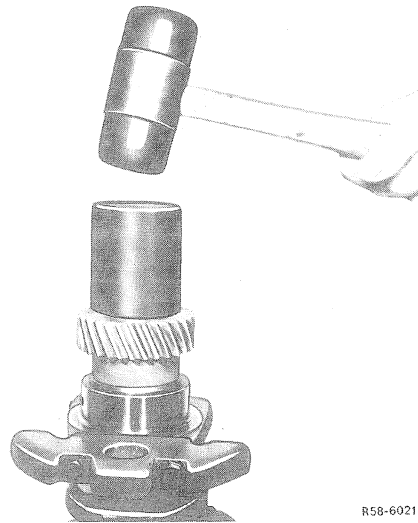

5 Mount radial ball bearing on crankshaft.

6 Insert bearing shell halves in correct sequence into crankcase and bearing caps. Make sure that the securing lugs of the bearing shells are perfectly seated in grooves and in basic bores.

Note: The lube holes in the upper main bearing shells should be in alignment with bores and housing.

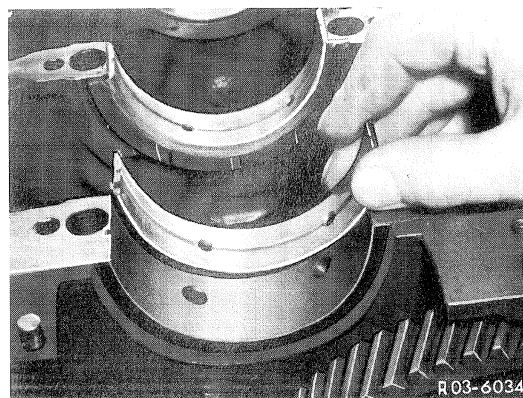

03.11 Installation of crankshaft

7 Moisten running surfaces of bearing shells with engine oil.

8 Place crankshaft into bearing shell.

Note: Make sure that the tooth of the crankshaft gear marked "1" is inserted between the teeth of the crankshaft gear also marked "1-1".

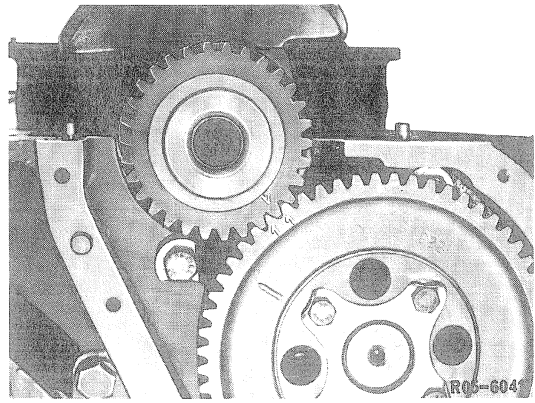

9 Mount main bearing cap with bearing shells. Make sure that the markings of the respective bearings are in alignment.

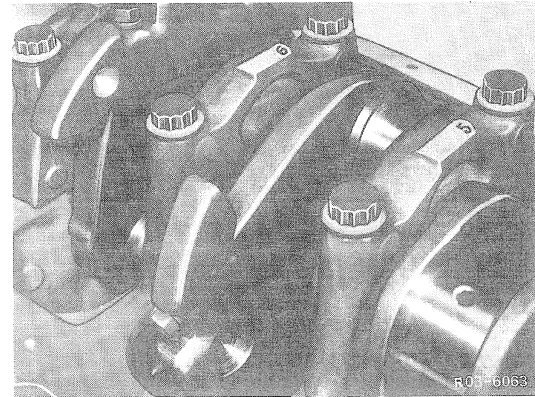

10 Screw-in main bearing bolts. Tighten by means of torque wrench 0001 589 39 21 01. Continue tightening bolts M 15 with angle of rotation tool 403 589 01 21 00.

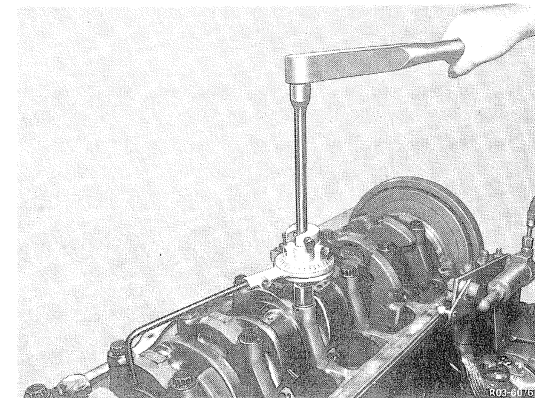

11 Attach holder 363 589 02 21 00 with dial gauge 001 589 53 21 00 to cylinder crankcase and measure end play of crankshaft.

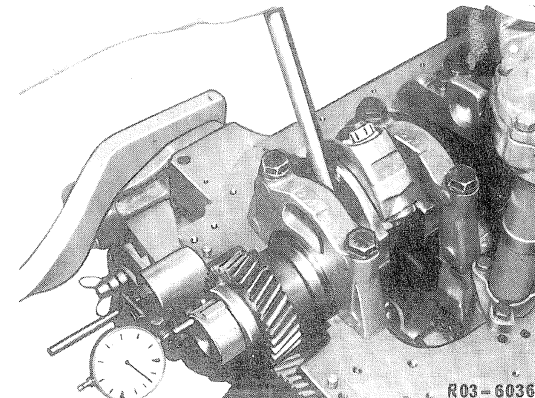

03.11

12 Insert connecting rod bearing shells into connecting rod and mount connecting rod bearing cap, moisten running surfaces with oil. Make sure that the securing lugs in grooves are perfectly seated.

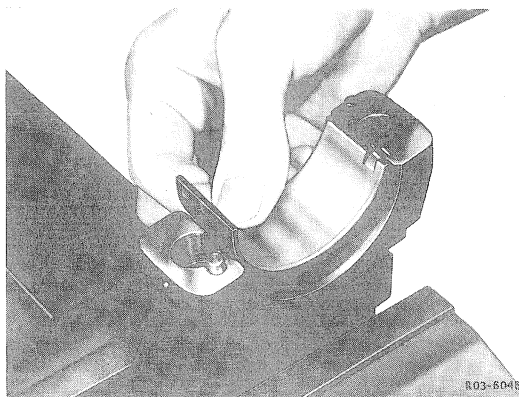

13 Pull connecting rods against crankpins.

14 Mount connecting rod bearing cap with bearing shells. Make sure that the markings of mating bearings are in alignment (numerals should be on one side). Screw-in fastening bolts.



15 Screw angle of rotation tool 403 589 01 21 00 to extension for socket wrench.

16 Tighten connecting rod bearing bolts with torque wrench 001 589 39 21 00 and continue tightening with angle of rotation tool at $90^\circ + 20^\circ$.

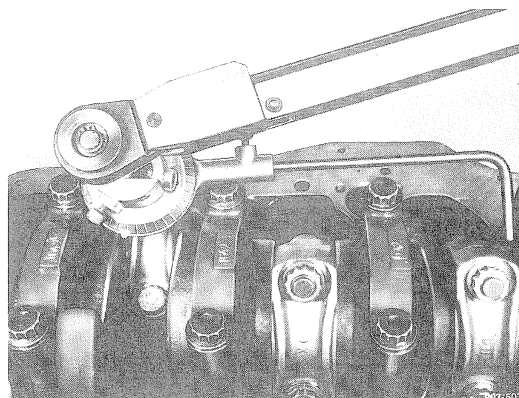

03.11 Mounting of crankshaft

OM 314

Data

Repair stage	Diameter of bearing journals	Bearing bore in installed condition	Wall thickness for bearing shells ready for installation	Width of fitted bearing
Normal	88.010	88.080	2.465–2.477	32.062 32.000
	87.990	88.060		
Normal I	87.910	87.980	2.515–2.527	
	87.890	87.960		
Rep. stage I	87.760	87.830	2.590–2.602	
	87.740	87.810		
Rep. stage II	87.510	87.580	2.715–2.727	
	87.490	87.560		
Rep. stage III	87.260	87.330	2.840–2.852	
	87.240	87.310		
Rep. stage IV	87.010	87.080	2.965–2.977	
	86.990	87.060		
Basic bore dia. for crankshaft bearings in cylinder crankcase			93.022	
			93.000	
Overlap of crankshaft bearing shell halves in basic bore			0.078	
			0.025	
Perm. out-of-round of crankpins			0.01	
Perm. conicity of crankpins			0.01	

Tightening torques in Nm (kpm)

Main bearing bolts	up to engine end no. 000 282	M 14	120 (12)
	starting engine end no. 000 283	M 14	140 (14)
		M 15 ¹⁾	Initial torque 50+10 (5+1) Final torque 90° + 20°

¹⁾ M 15 can be used again up to max. shank length 123 mm.



03.11

Special tools

Dial gauge	001 589 53 21 00
Torque wrench 20–100 Nm (2–10 kpm)	000 589 64 21 00
Torque wrench 80–300 Nm (8–30 kpm)	001 589 39 21 01
Angle of rotation tool	403 589 01 21 00

Mounting of crankshaft

Note: The bearing shells for crankshaft, no matter which repair stage, are supplied ex factory ready for installation. No refinishing of bearing shells is permitted.

1 Clean bearing surfaces in crankcase and bearing cap with chamois leather.

2 Insert bearing shell halves into crankcase and into bearing caps in correct sequence. Make sure that the securing lugs of the bearing shells are perfectly seated in grooves and in basic bores.

Note: The main bearing shells in housing are provided with an oil hole and should be properly aligned with oil hole in housing.

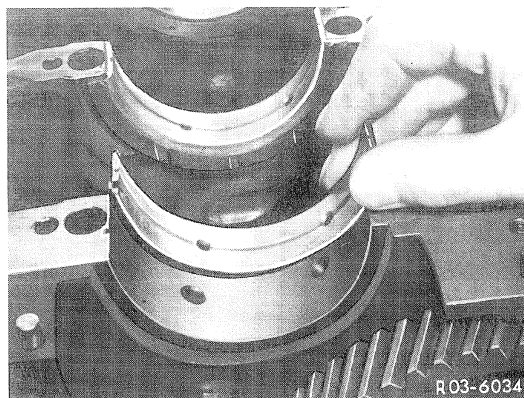

3 Insert bearing caps with bearing shells into crankcase. Make sure that the markings of mating bearings are in alignment.

4 Screw-in main bearing bolts and tighten according to engine number or size of main bearing bolts by means of torque wrench 001 589 39 21 01 or 000 589 64 21 00 and angle of rotation tool 403 589 01 21 00.

03.11 Mounting of crankshaft

5 Attach dial gauge 001 589 53 21 00 to internal measuring instrument. Set internal measuring instrument 50–100 mm dia. with micrometer 75–100 mm dia. to zero dimension of main bearing bore.

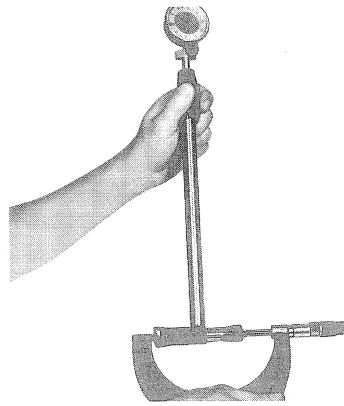

R03-6014

6 Measure main bearing bore with internal measuring instrument 50–100 mm dia. at three points (vertically and each approx. 30° from parting surfaces top and bottom).

Note: The values named in table must be maintained.

7 Remove bearing cap again.

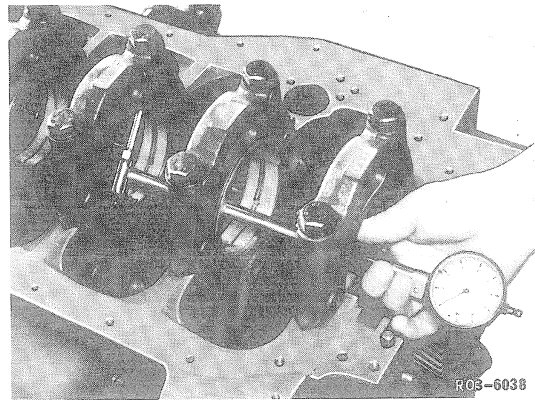

R03-6038



05.11 Exploded views

OM 314

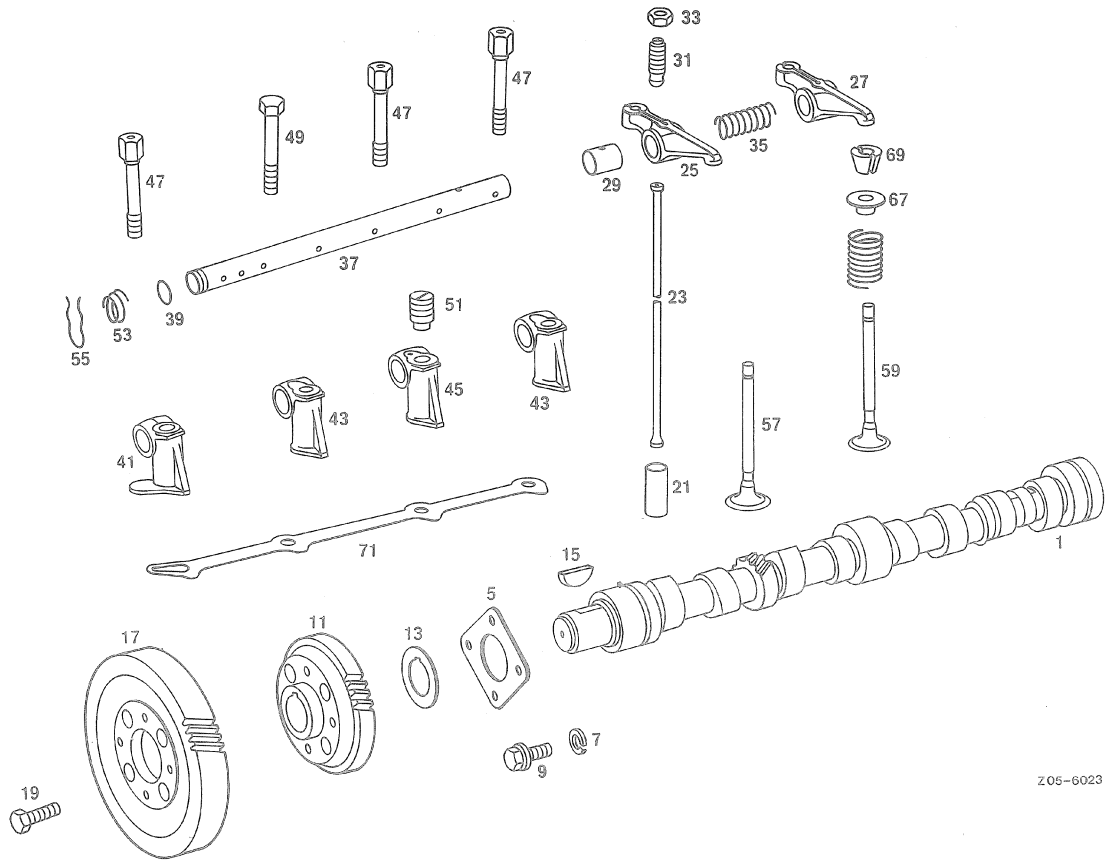

Camshaft

- | | | | | | |
|----|----------------|----|--------------------|----|-----------------|
| 1 | Camshaft | 27 | Rocker arm | 49 | Screw |
| 5 | Pressure plate | 29 | Bushing | 51 | Threaded pin |
| 7 | Snap ring | 31 | Ball pin | 53 | Spring |
| 9 | Screw | 33 | Nut | 55 | Spring |
| 11 | Drive gear | 35 | Spring | 57 | Intake valve |
| 13 | Spacing ring | 37 | Rocker arm shaft | 59 | Exhaust valve |
| 15 | Woodruff key | 39 | Washer | 65 | Valve spring |
| 19 | Screw | 41 | Rocker arm bracket | 67 | Spring retainer |
| 21 | Valve tappet | 43 | Rocker arm bracket | 69 | Cone |
| 23 | Push rod | 45 | Rocker arm bracket | 71 | Shim |
| 25 | Rocker arm | 47 | Screw | | |

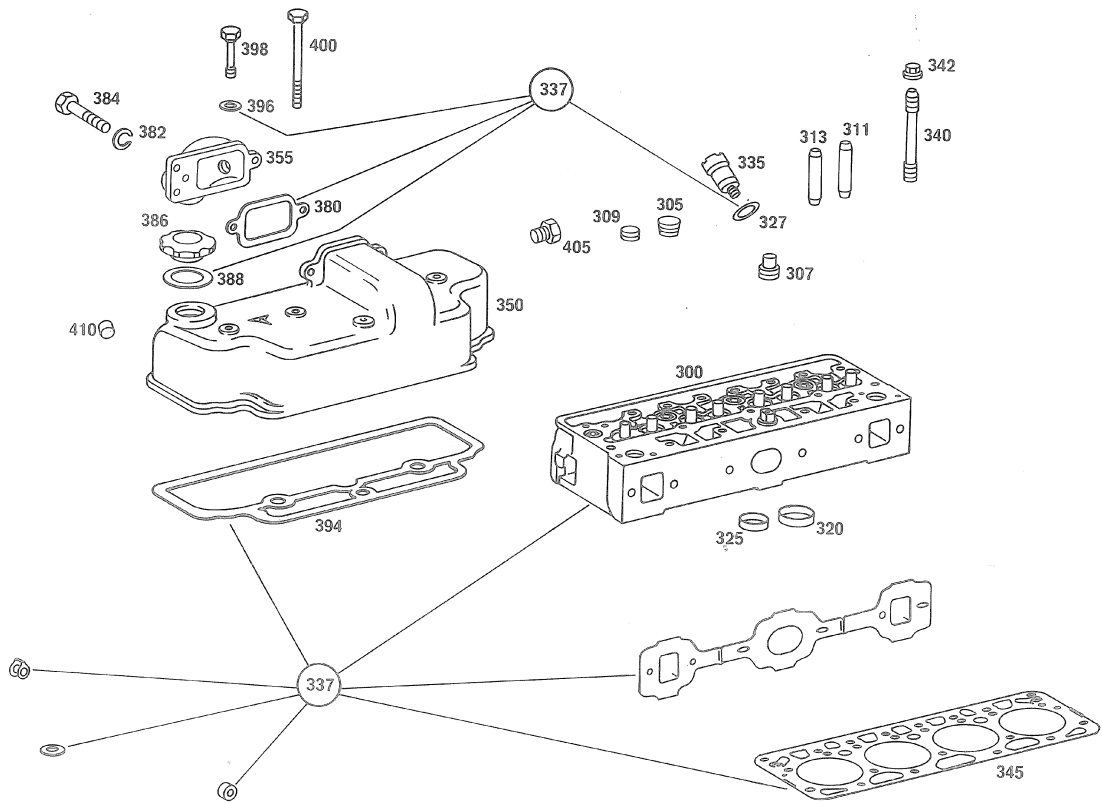

Z05-6024

Cylinder head

- 300 Cylinder head
- 305 Closing plug
- 307 Plug
- 309 Closing plug
- 311 Valve guide
- 313 Valve guide
- 320 Valve seat ring
- 325 Valve seat ring
- 327 Sealing ring

- 335 Spacing tube
- 337 Sealing set
- 340 Stud
- 342 Nut
- 345 Cylinder head gasket
- 350 Cylinder head cover
- 355 Connection
- 380 Gasket
- 382 Bolt

- 384 Snap ring
- 386 Closing cover
- 388 Sealing ring
- 394 Gasket
- 396 Sealing ring
- 398 Screw
- 400 Screw
- 405 Screw
- 410 Plug

05.11 Adjustment of valve clearance (method 1)

OM 314

Data

Valve clearance (cooling water temperature max. 50° C)	Intake	0.20
	Exhaust	0.30
Firing order		1-3-4-2
Overlap		4-2-1-3

Tightening torque in Nm (kpm)

Cylinder head cover	25 (2.5)
---------------------	----------

Special tools

Valve adjusting wrench	321 589 00 11 00
Torque wrench 20-100 Nm (2-10 kpm)	000 589 64 21 00
Slip gauge 0.20 mm	117 589 00 23 00
Slip gauge 0.30 mm	617 589 02 23 00
Slip gauge holder	617 589 00 40 00
Slip gauge holder	617 589 05 40 00

Adjustment of valve clearance

- 1 Remove cylinder head cover.
- 2 Rotate engine until piston of cylinder about to be adjusted is at TDC. The valves must be closed, the rocker arms free of any load, and the push rods should turn easily in ball sockets. The valves should overlap at synchronous cylinder.



05.11

3 Slide slip gauge 117 589 00 23 00 with slip gauge holder 617 589 05 40 00 between intake valve and rocker arm or slip gauge 617 589 02 23 00 with slip gauge holder 617 589 00 40 00 between exhaust valve and rocker arm. Valve clearance is correctly set, when the slip gauge can be pulled through at a slight resistance.

4 If valve clearance must be corrected adjust by placing valve adjusting wrench 321 589 00 11 00 on adjusting screw, loosen counternut and correct valve clearance. Tighten counternut again, while keeping adjusting nut in place.

5 Mount cylinder head cover with new gasket and tighten fastening screws to specified torque using torque wrench 000 589 64 21 00.

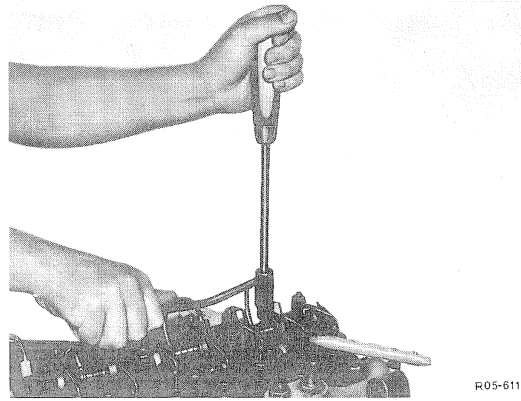

05.11 Adjustment of valve clearance (method 2)

OM 314

Data

Valve clearance		Intake	0.20
		Exhaust	0.30
Engine	Engine position cylinder 1	Intake valves to be adjusted	Exhaust valves to be adjusted
OM 314	Begin of delivery at overlap TDC	3.4	2.4
	Begin fo delivery at ignition TDC	1.2	1.3

Tightening torques in Nm (kpm)

Cylinder head cover	25 (2.5)
---------------------	----------

Special tools

Valve adjusting wrench	321 589 00 11 00
Torque wrench 20–100 Nm (2–10 kpm)	000 589 64 21 00
Slip gauge 0.20 mm	117 589 00 23 00
Slip gauge 0.30 mm	617 589 02 23 00
Slip gauge holder	617 589 00 40 00
Slip gauge holder	617 589 05 40 00

Adjustment of valve clearance

- 1 Remove cylinder head cover.
- 2 Rotate engine in direction of rotation until begin of delivery (FB) mark on pulley is in alignment with adjustment indicator on timing housing.

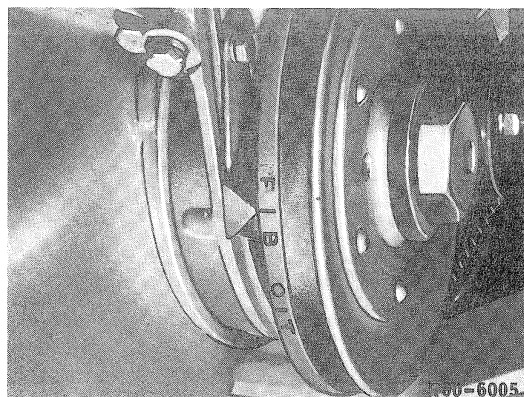

05.11

Note: A double indicator is mounted starting engine end no. 051 953 (85 HP).

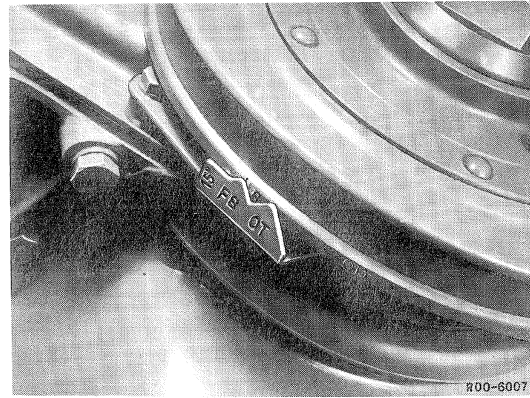

3 Check whether 1st cylinder is at ignition TDC or at overlap TDC (at ignition TDC both valves are closed, the rocker arms are without any load and the push rods should rotate easily).

Note: The cylinder sequence is shown in diagram.

At **ignition TDC** the following valves can be adjusted:

Intake valve	Exhaust valve
1.2	1.3

At **overlap TDC** the following valves can be adjusted:

Intake valve	Exhaust valve
3.4	2.4

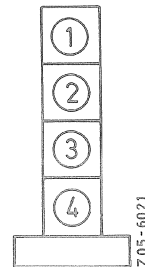

4 Slide slip gauge 117 589 00 23 00 with slip gauge holder 617 589 05 40 00 between intake valve and rocker arm or slip gauge 617 589 02 23 00 with slip gauge holder 617 589 00 40 00 between exhaust valve and rocker arm. Valve clearance is correctly set, when the slip gauge can be pulled through at slight resistance.

5 If the valve clearance must be corrected, adjust by placing valve adjusting wrench 321 589 00 11 00 on adjusting screw, then loosen counternut and correct valve clearance. Tighten counternut again, while keeping adjusting screw in place.

6 Mount cylinder head covers with new gasket and tighten fastening screws to specified torque with torque wrench 000 589 27 21 00.

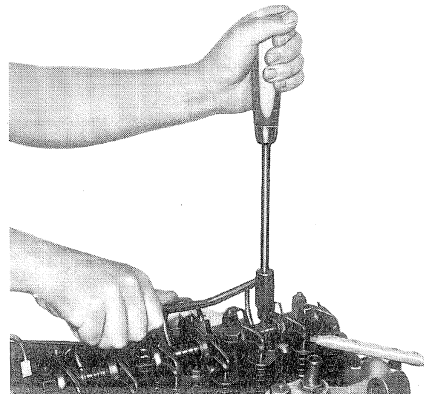

05.11 Removal and installation of cylinder head cover

OM 314

Tightening torque in Nm (kpm)

Cylinder head cover to cylinder head	25 (2.5)
--------------------------------------	----------

Special tool

Torque wrench 20–100 Nm (2–10 kpm)	000 589 64 21 00
------------------------------------	------------------

Removal

- 1 Loosen hose clip of accordion hose on connection of cylinder head cover and pull off hose.
- 2 Unscrew intake pipe for air compressor from connection of cylinder head cover.
- 3 Unscrew fastening screws for cylinder head cover.
- 4 Remove cylinder head cover.
- 5 Remove gasket

Installation

- 1 Check sealing surface of cylinder head cover for damage.
- 2 Mount new gasket on cylinder head.
- 3 Mount cylinder head cover. Tighten screws with torque wrench 000 589 64 21 00 to specified torque.

Note: When attaching cylinder head cover, tighten screw above intake ducts first.

- 4 Screw intake pipe for air compressor to connection of cylinder head cover by means of hollow screw.
- 5 Slip accordion hose for charging air over connection and attach with hose clip.

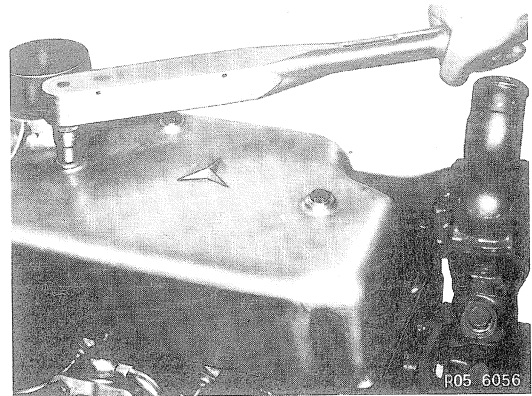

05.11 Removal of cylinder head

Initial jobs

Clean complete upper engine section, so that no dirt can enter valve area. Unscrew cylinder head cover.

Removal

- 1 Drain cooling water and, if mixed with an anti-freeze, catch in a clean vessel.
 - 2 Unscrew fuel filter.
 - 3 Remove upper cooling water line.
 - 4 Remove injection pressure lines.
 - 5 Remove rocker arm assembly.
 - 6 Remove push rods.
 - 7 With engine brake installed, disconnect pull rod at throttle valve lever.
 - 8 Unscrew exhaust pipe from exhaust manifold.
 - 9 Loosen cylinder head nuts.
 - 10 Unscrew studs.
 - 11 Screw handles 312 589 01 31 00 into cylinder head.
 - 12 Lift off cylinder head.
- Note:** Put cylinder head away on side only, so that nozzle is not damaged.
- 13 Remove cylinder head gasket. Clean supporting surfaces from residue.
 - 14 Blow out threaded holes for studs.

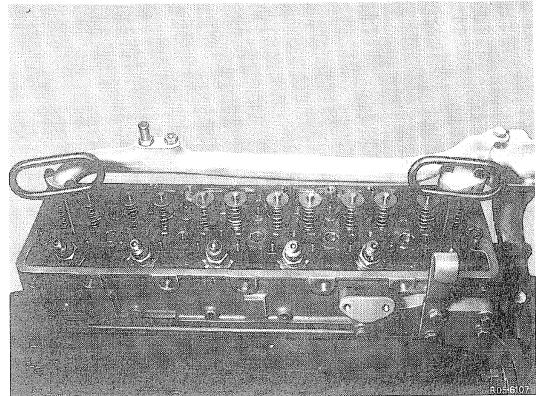

05.11 Installation of cylinder head

OM 314

Data

Total height of cylinder head	92.1 91.9
Perm. total material allowance ¹⁾	1.0
Perm. unevenness of lower parting surface along length of 150 mm	0.05
Perm. deviation in parallel between upper and lower parting surface	0.1
Nozzle standout	1.8–2.5

¹⁾ Upon machining of cylinder head parting surface, check nozzle standout and make corrections with small nozzle plates, if required.

Tightening torques in Nm (kpm)

Tighten cylinder head in three steps	1st step 60 (6) 2nd step 90 (9) 3rd step 110 (11)
Cylinder head cover	25 (2.5)
Coupling nut injection line	25 (2.5)
Upper cooling water line	30 (3)
Rocker arm brackets	100–110 (10–11)
Exhaust pipe to exhaust manifold	45 (4.5)

Special tools

Special wrench	000 589 06 03 00
Special wrench for injection lines	000 589 21 07 00
Torque wrench 20–100 Nm (2–10 kpm)	000 589 64 21 00
Torque wrench 80–300 Nm (8–30 kpm)	001 589 39 21 01
Handles	312 589 01 31 00

Installation of cylinder head

- 1 Mount cylinder head gasket.
- 2 Mount cylinder head. Unscrew handles 312 589 01 31 00.
- 3 Lubricate threads of studs.

Note: Do not pour oil into threaded holes.

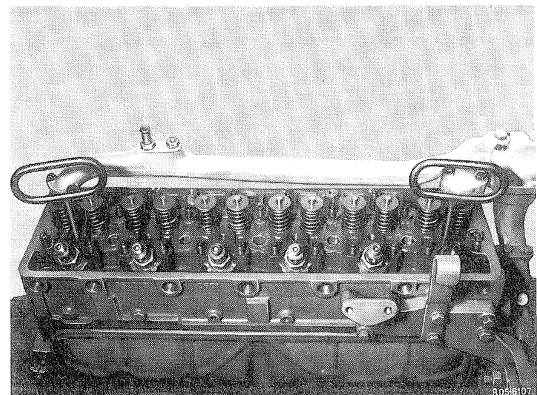

05.11

- 4 Insert studs and tighten with screwdriver.
- 5 Screw cylinder head nuts on studs and tighten in 33 steps in sequence of tightening diagram, using torque wrench 000 589 64 21 00 and 001 589 39 21 01.
- 6 Install push rods.

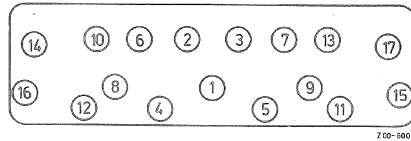

- 7 Mount rocker arm assembly and tighten with torque wrench 001 589 39 21 01.
- 8 Install injection pressure lines.
- 9 Screw exhaust pipe to exhaust manifold.
- 10 With engine brake installed, attach pull rod to throttle valve lever and secure.
- 11 Install upper cooling water line with new gasket.
- 12 Screw fuel filter to cylinder head.
- 13 Screw guide tube for oil dipstick to cylinder head.
- 14 Adjust valves.
- 15 Attach cylinder head cover.
- 16 Fill in cooling water.

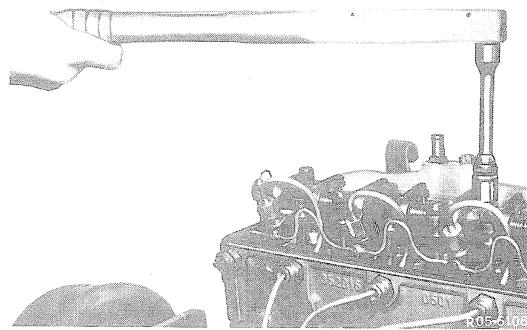

Attention! Following assembly, run engine to operating temperature, then loosen each nut individually in sequence of tightening diagram slightly and then tighten to torque of 110 Nm (11 kpm). Never loosen all nuts at the same time and then tighten. Then readjust valves. After another 500 km, tighten cylinder head nuts once again and readjust valves.

Note: The nuts under rocker arm shaft can be tightened with special wrench 000 589 06 03 00 without removing rocker arm assembly.

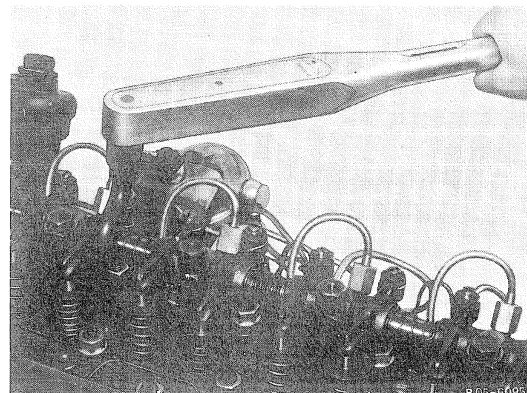

05.11 Removal and installation of valves (cylinder head removed)

OM 314

Valve springs

ID	Wire dia.	unloaded length	length ¹⁾	preloaded load	length ²⁾	Final load load
25 + 0.4	4.25	60.5	46.7	300 ± 15 N (30 ± 1.5 kp)	35.18	590 ⁺⁴⁰ ₋₂₀ N (59 ⁺⁴ ₋₂ kp)

¹⁾ in installed condition corresponds to length with valve closed

²⁾ in installed condition corresponds to length with valve opened

Removal

- 1 Mount cylinder head on supporting surface of valve mounting fixture and tighten with clamping jaws.
- 2 Adjust push fork to diameter of valve spring retainer.
- 3 Introduce push rod into lever eye and push valve spring retainer down. Apply counterhold to valve from below.
- 4 Remove cone halves from valve stem.
- 5 Relieve push rod. Remove valve spring retainer, valve spring and valve.
- 6 Remove washer for valve spring.
- 7 Remove cylinder head from valve mounting fixture.

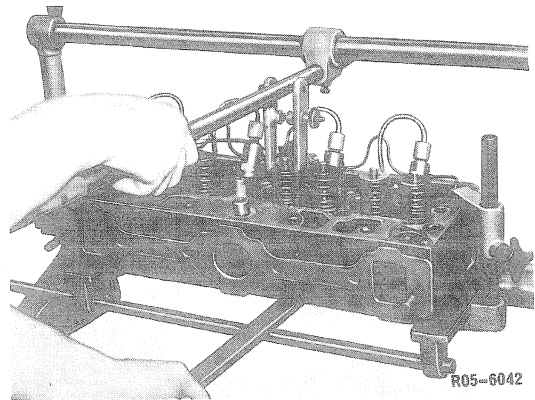

Installation

- 1 Tighten cylinder head to valve mounting fixture.
- 2 Insert washer for valve spring, valve spring itself and valve spring retainer.
- 3 Lubricate valve stem, introduce from below into cylinder head and apply counterhold to valve.



05.11

4 Introduce pushrod into lever eye and push down valve spring retainer. Insert tapered ring halves into groove of valve stem. Slowly release valve spring lifter.

Make sure that the valve spring is correctly mounted in valve retainer and that the valve cone halves are correctly located in groove of valve and in valve disc.

5 Remove valve spring lifter.

6 Remove cylinder head from valve mounting fixture.

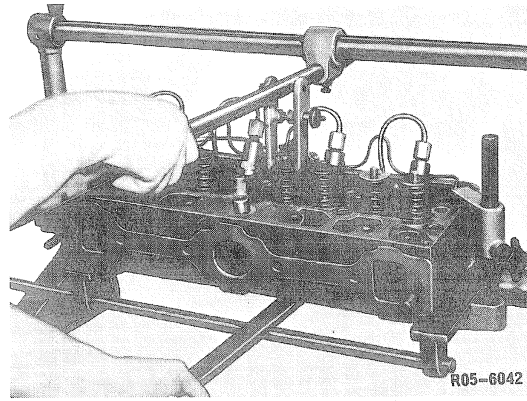

05.11 Machining valve seats

OM 314

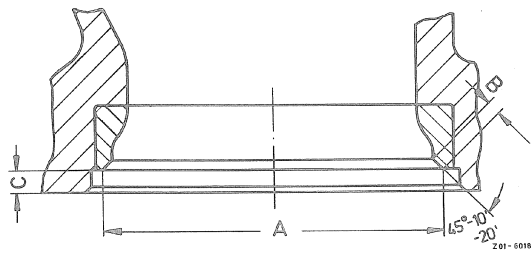

Intake

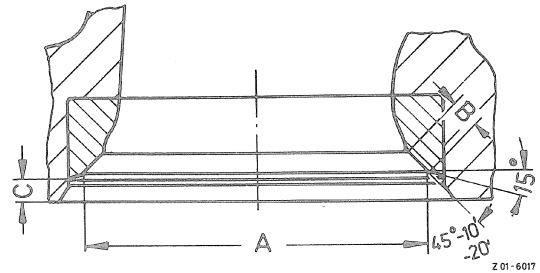

Exhaust

Data

Valve seat angle	Intake	45°
	Exhaust	45°
Dia. "A" of valve seat on new seat rings	Intake	$\frac{43.4}{43.2}$
	Exhaust	$\frac{35.4}{35.2}$
Width "B"	Intake	1.6-2
	Exhaust	2.0-2.5
Dimension "C" reference dimension	Intake	2.8 + 0.2
	Exhaust	2.6 + 0.2

If the machining allowance is exceeded while refinishing valve seat, replace valve seat rings.

Special tool

Valve seat machining tool for trucks	000 589 16 69 00
--------------------------------------	------------------



05.11

Machining valve seats

Note: Valve guides are installed.

- 1 Mount cylinder head on valve mounting fixture.
- 2 Measure valve seat dia.

Note: When valve seats are slightly dented, refinishing can be performed without renewing valve seat ring, provided the machining allowance is not exceeded.

- 3 Enter pilot into valve guide until stop of slotted rod rests on valve guide, push slotted rod down with screwdriver, if required. Tighten pilot.
- 4 Screw machining bit to carriage.

Note: Make sure that machining bit is mounted on carriage in correctly graduated position. Make free carriage inoperative by loosening coupling nut. Mount crank handle to arm marked 45°.

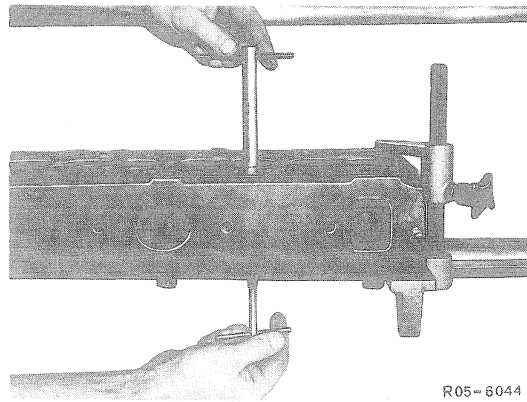

- 5 Loosen coupling nut (2), slide machining bit over pilot and move quick adjustment by means of turning screw (1) in such a manner that the machining bit comes to rest on center of valve seat.

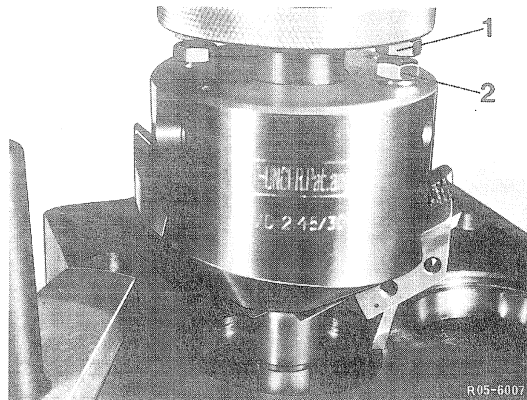

- 6 Push pilot support (1) on pilot down and clamp down by means of screw (2), while the knurled screw (3) is screwed down and the fastening screw (4) should be tightened.

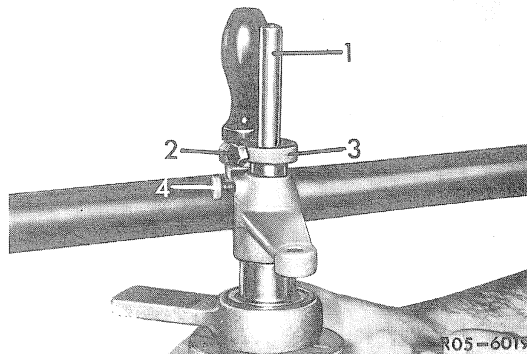

05.11 Machining valve seats

7 Move backrest rod with hand crank into correct position in relation to work. Tighten swing guide horizontally approx. in center of guide by means of backrest clamp. Machining tool should now turn as easily as before.

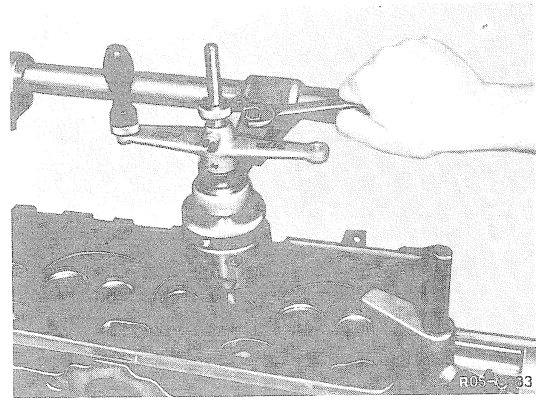

8 Move machining bit adjacent to inner feed edge by turning rapid adjustment, then tighten coupling nut. Do not yet set to required chip.

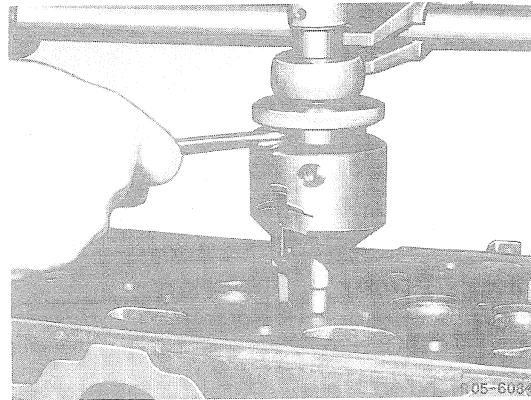

9 Hold feed actuation in place and turn crank. In most cases, an irregular chip removal will show up. After finishing cut, loosen coupling nut of rapid adjustment and move bit again inwards.

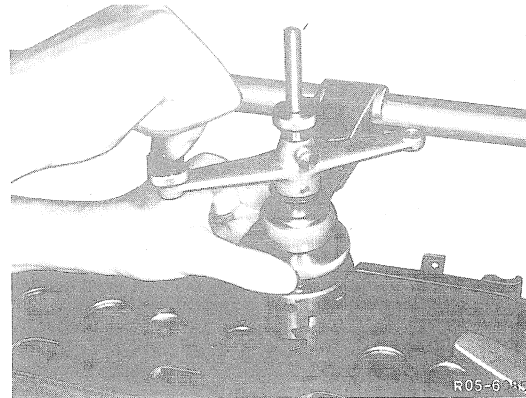

10 Loosen fastening screw (1) and turn knurled disc (2) about 1/2 to 2 graduation marks (1 graduation mark = 0.1 mm) to the left. Tighten fastening screw (1) and coupling nut again, then start another machining step.

11 Hold feed actuation in place and turn crank until tip of machining bit has moved outwards.

12 Repeat cutting step until seat is clean (do not exceed machining allowance). Then perform one more machining step without increasing chip feed. With newly installed valve seat rings, the values shown in table must be attained.

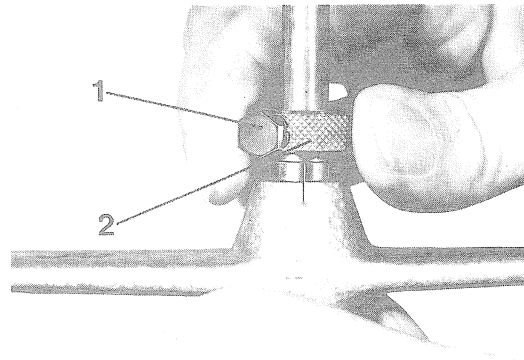

05.11 Grinding valves

OM 314

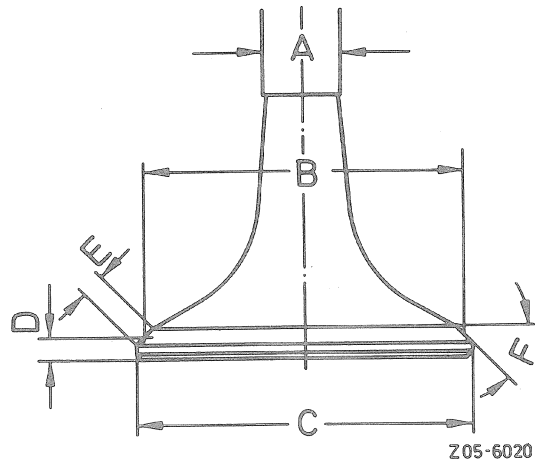

Data

	Valve seat "F"	Valve disc dia "C"	Stem dia "A"	Length of valve	Diameter "B"	when new	Height "D" machining allowance	Valve seat width "E"	Hardness at valve stem end
Intake	45°	44.10	8.950	140.7	42.01	2.8	2.1	3.5	HRc = 57 ± 3
		43.90	8.935	140.3	41.99	2.5		2.8	
Exhaust	45°	36.10	9.940 ¹⁾	140.7	34.01	2.8	2.7	4.2	HRc = 57 ± 3
		35.90	9.925	140.3	33.99	2.5		3.5	

¹⁾ $\frac{8.940}{8.925}$ up to engine end no. 42 965

Perm. runout between valve seat and stem	0.03
Perm. runout between valve disc and stem	0.20
Perm. out-of-round of valve seat	0.01

Grinding valves

- 1 Clean removed valves, remove adhering oil carbon.
- 2 Check valves for further use. Be sure to replace burnt valves.
- 3 Check valves for out-of-round and runout. Straightening of valves is not permitted.
- 4 Slight deviations from out-of-round can be corrected by regrinding valve seat on a valve grinding machine.



05.11

5 Clamp valve as closely behind valve disc as possible to eliminate annoying vibrations.

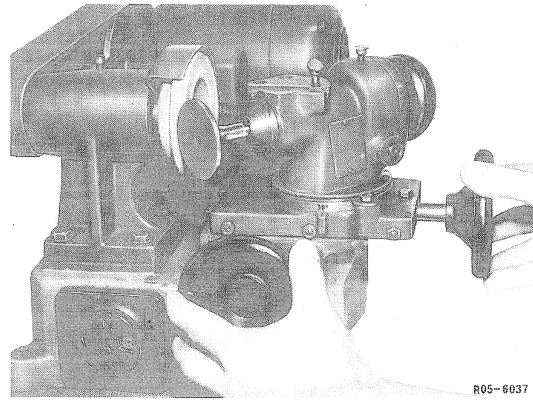

6 Adjust cranking angle on scale.

7 Take valve with feed slowly against running grinding wheel until wheel comes into contact with seat of valve.

8 Continue grinding at slow feed until valve seat is cleaned all around circumference.

Note: Following this grinding step, dimension "D" named on table should not be below specified dimension.

9 The flat grinding of the valve stem ends can be completed by means the vee-block on valve grinding machine.

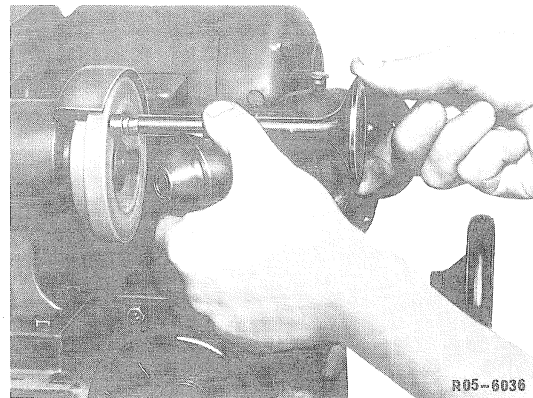

05.11 Removal and installation of valve guides

OM 314

Data

Stages	OD	Valve guide ID		Length of valve guide		Bore in cylinder head	Over-lap in cyl. head	Clearance of valve stem in valve guide	
		Intake	Exhaust ¹⁾	Intake	Exhaust			Intake	Exhaust
Normal	15.046					15.018			
	15.028					15.000			
Rep. stage I	15.146					15.118			
	15.128	9.022 ²⁾	10.022 ³⁾	78	73	15.100	0.010 to 0.046	0.050 to 0.087	0.060 to 0.097
Rep. stage II	15.246	9.000	10.000			15.218			
	15.228					15.200			
Rep. stage III	15.546					15.518			
	15.528					15.500			

¹⁾ $\frac{9.022}{9.000}$ up to engine end no. 042 965.

²⁾ If repaired, max. 9.050

³⁾ If repaired, maxi. 10.050

Perm. center offset of valve seat in relation to valve guide 0.03

Perm. deviation from squareness of valve seat in relation to valve guide 0.01

Distance from valve guide to support of valve spring dimension "A" 24.5-0.5

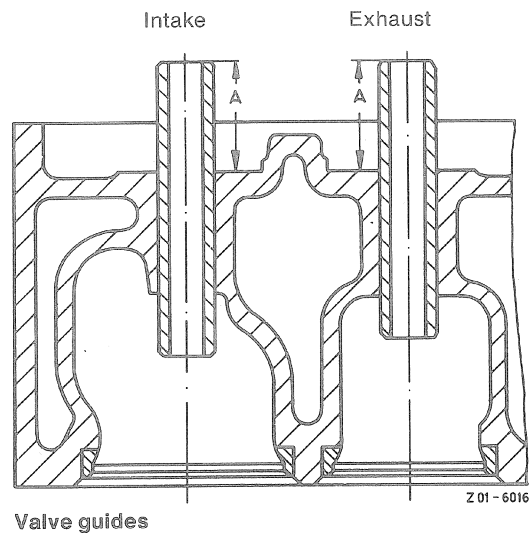

05.11

Special tools

Mandrel for removing valve guides 10 mm dia.	615 589 01 15 00
Mandrel for removing valve guides 9 mm dia.	110 589 02 15 00
Mandrel with bushing for installing valve guides	352 589 00 43 00
Reamer 9 mm dia.	000 589 10 53 00
Reamer 10 mm dia.	000 589 11 53 00
Adjustable reamer	000 589 18 53 00

Removal

- 1 Clamp cylinder head.
- 2 Knock valve guides out of cylinder head by means of mandrel 110 589 02 15 00 for 9 mm dia. valves or mandrel 615 589 01 15 00 for 10 mm dia. valves.

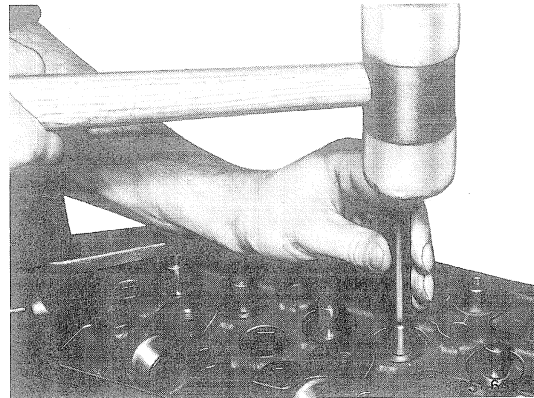

- 3 Ream bore in cylinder head with adjustable reamer 000 589 18 53 00 to next higher repair stage.

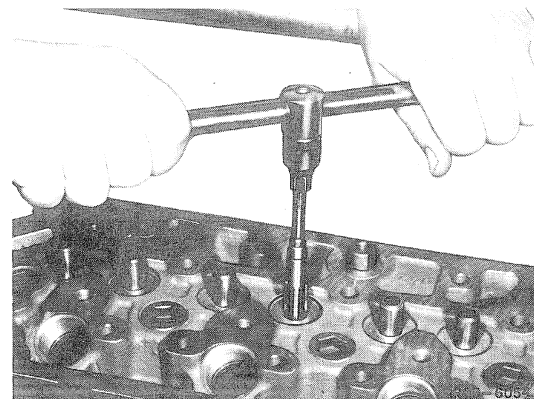

05.11 Removal and installation of valve guides

Installation

1 Coat new valve guide with graphite-treated oil and position in bore of cylinder head.

2 Slip spacing sleeve of special tool 352 589 00 43 00 over valve guide.

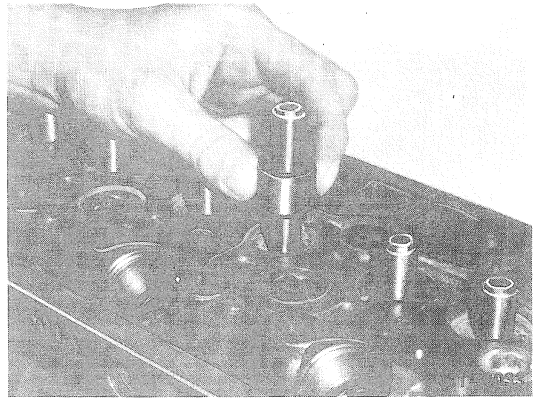

3 Force valve guide into heated cylinder head with mandrel 352 589 00 43 00.

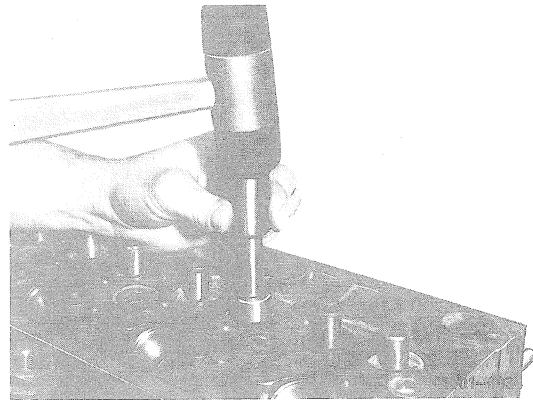

4 Ream ID of valve guide depending on valve stem dia. with reamer 000 589 10 53 00 or 000 589 11 53 00.

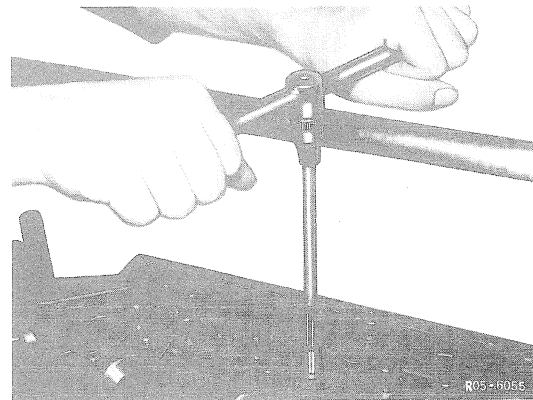

05.11 Renewing valve seat rings (cylinder head and valves removed)

OM 314

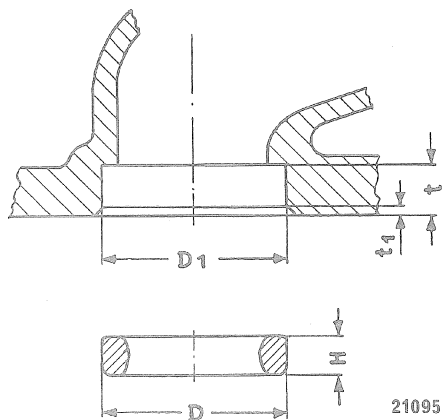

Data

	Intake valve seat ring			Exhaust valve seat ring		
	Normal	Normal I	Rep. stage I	Normal	Rep. stage I	Rep. stage II
OD "D" of valve seat ring	$\frac{45.080}{45.070}$	$\frac{45.380}{45.370}$	$\frac{45.580}{45.570}$	$\frac{38.080}{38.070}$	$\frac{38.380}{38.370}$	$\frac{38.580}{38.570}$
Basic bore "D 1" in cylinder head for valve seat ring	$\frac{45.025}{45.000}$	$\frac{45.325}{45.300}$	$\frac{45.525}{45.500}$	$\frac{38.025}{38.000}$	$\frac{38.325}{38.300}$	$\frac{38.525}{38.500}$
Overlap of valve seat ring in cylinder head	0.045–0.080			0.045–0.080		
Depth "t" of bore in cylinder head	$\frac{11.2}{11.1}$			$\frac{11.2}{11.1}$		
Height "H" of valve seat ring	$\frac{8.3}{8.2}$			$\frac{8.5}{8.4}$		
Distance "t 1" between parting surface of cylinder head and face of valve seat ring	2.8 + 0.2			2.6 + 0.2		



05.11

Special tools

Installation mandrel for intake and exhaust valve seat	346 589 03 15 00
Internal measuring instrument	000 589 33 19 00
Dial gauge	000 589 14 21 00
Internal puller for exhaust valve seat ring	000 589 28 33 00
Internal puller intake valve seat ring	000 589 29 33 00
Countersupport	000 589 34 33 00
Pliers	000 589 35 37 00
Undercooling box	346 589 00 63 00
Ring seat machining tool	000 589 10 69 00

Removal, inspection

Note: Valve guides are installed.

- 1 Clamp cylinder head on valve mounting fixture.
- 2 Introduce pilot into valve guide until stop of slotted rod rests on valve guide, push slotted rod down with screwdriver, if required. Tighten with mandrel introduced at top and bottom into pilot.

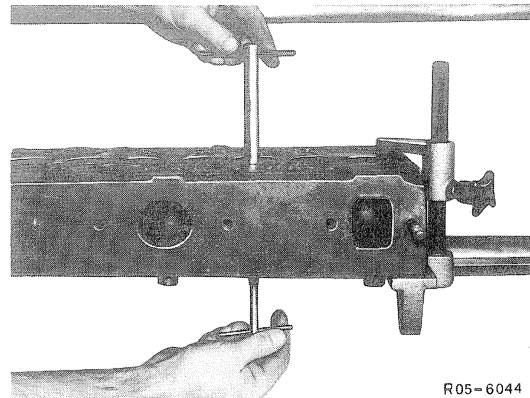

R05-6044

- 3 Clamp machining bit for ring groove into carriage.

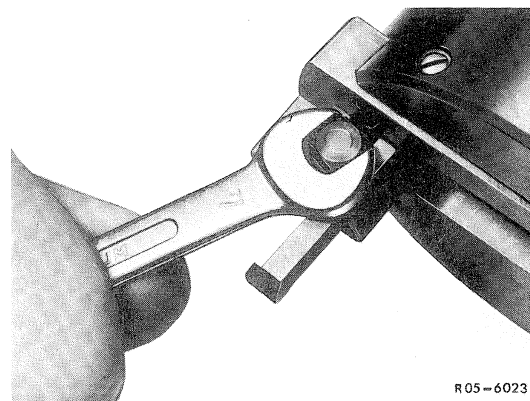

R05-6023

05.11 Renewing valve seat rings (cylinder head and valves removed)

4 Loosen counternut (2). Introduce machining tool over pilot coated with oil, turn screw (1, rapid adjustment) until machining tool rests against pilot, then push machining tool downwards until machining bit is in center of valve seat ring.

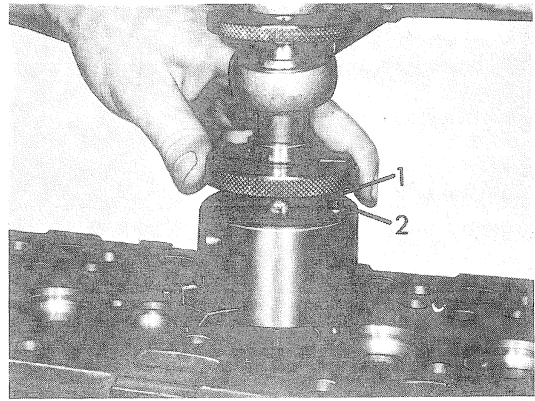

5 Hold machining tool in this position, loosen fastening screw (1) of pilot support, push pilot support (2) downwards until support rests on pilot. Tighten fastening screw (1) again.

6 Move backrest rod with hand crank into suitable position in relation to work. Clamp swing guide horizontally approximately in center of guide by means of backrest clamp. The machining tool should now turn as easily as before.

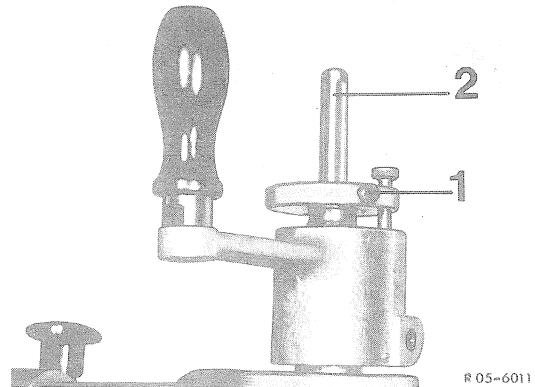

7 Turn screw of rapid adjustment (1) back until machining bit is close to valve seat ring, but is not yet making contact. Tighten counternut (2). Turn horizontal stop screw (3) until screw rests against housing and then turn back 2 to 3 mm. Tighten clamping screw (4) located underneath.

8 Adjust machining bit height in such a manner that upon machining **approx. 1 mm** of material still remains at bottom on valve seat ring.

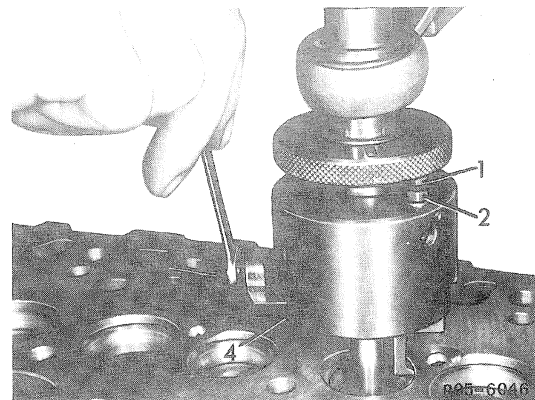

Note: By holding knurled disc (2) in place and turning crank of machining tool to the right, the machining bit will move downwards, while by turning to the left the machining bit will move upwards.

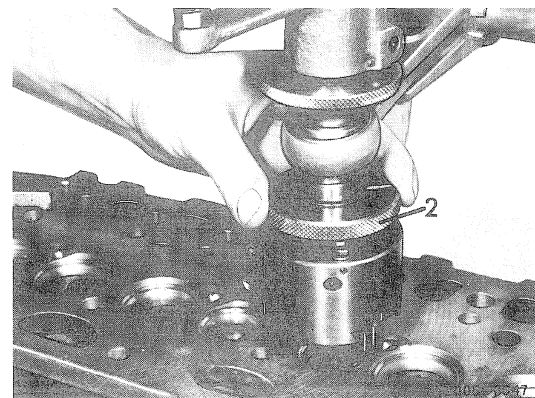

05.11

9 Machine ring groove into valve seat ring by turning machining tool while simultaneously holding knurled disc (2) in place, but releasing disc occasionally when the machining resistance increases. Depth of ring groove approx. 2 to 3 mm.

Note: Feed should not be excessive. The machining tool should turn easily, which is obtained by releasing knurled disc (2) for a short moment.



10 Remove machining tool.

11 Position internal puller 000 589 28 33 00 or 000 589 29 33 00 in ring groove, tighten nut and pull out with countersupport 000 589 34 33 00.

Note: Place rubber shims under supports of countersupport to avoid damaging cylinder head surface.

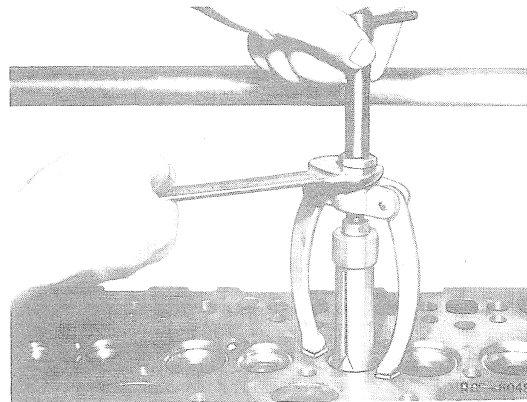

12 Adjust internal measuring instrument 000 589 33 19 00 with micrometer.

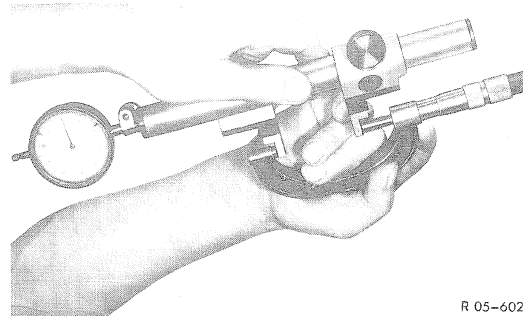

13 Measure bores for valve seat rings in cylinder head with internal measuring instrument 000 589 33 19 00.

Note: If dimensions differ from data shown on table, machine bores to next stage.

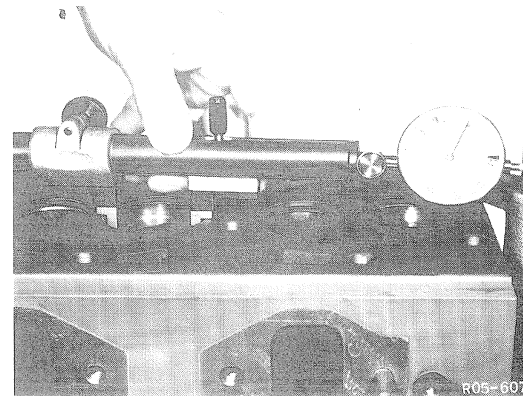

05.11 Renewing valve seat rings (cylinder head and valves removed)

Refinishing basic bore

- 1 Clamp machining bits into carriage.
- 2 Introduce pilot into valve guide, until stop of slotted rod rests on valve guide and push slotted rod down with screwdriver, if required. Tighten with mandrel inserted from above and from below into pilot.

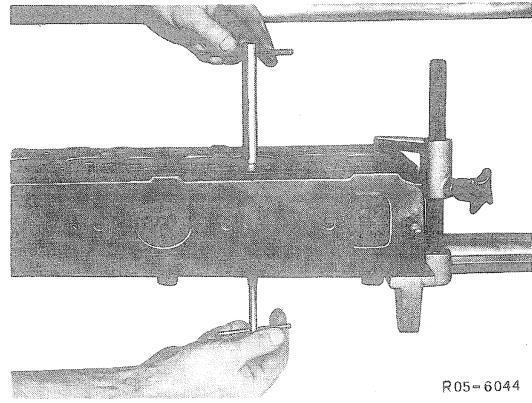

- 3 Loosen counternut (1). Slip machining tool over pilot coated with oil, turn adjusting screw (2) until machining bit is beyond bore, then push machining bit downwards until it rests on cylinder head.

Attention! Position tools carefully, so that carbide tip of machining bit is not damaged.

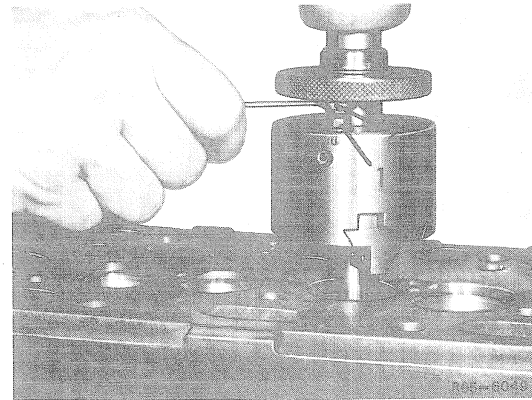

- 4 Loosen fastening screw (1), push pilot support (2) downwards until it rests on pilot, tighten fastening screw (1) again.

- 5 Turn knurled disc to adjust height of machining bit in such a manner that no contact is established.

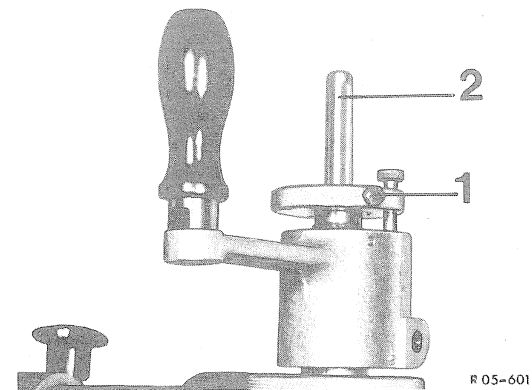

- 6 Clamp swing guide horizontally with backrest clamp, while setting working depth (working dimension "t") between adjusting ring and swing guide.

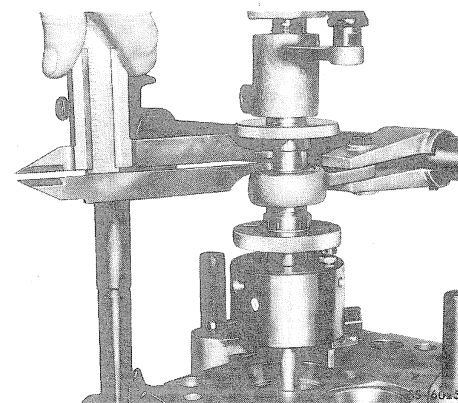

05.11

7 Computation of adjusting dimension "2":
Adjusting dimension "2" is basic bore "D 1" (table column "D 1" and pilot diameter "1" divided by 2.

$$\text{"2"} = \frac{D1 + 1}{2}$$

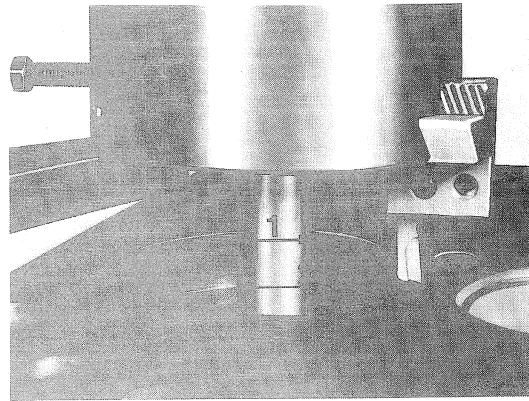

8 Loosen coupling nut, adjust micrometer to dimension "2". Slightly raise machining tool, position micrometer against pilot, set accurately to dimension "2" by means of rapid adjustment (1). Tighten coupling nut (2).

Note: It will be of advantage to set the machining bit for the first cut 0.1 mm less in diameter.

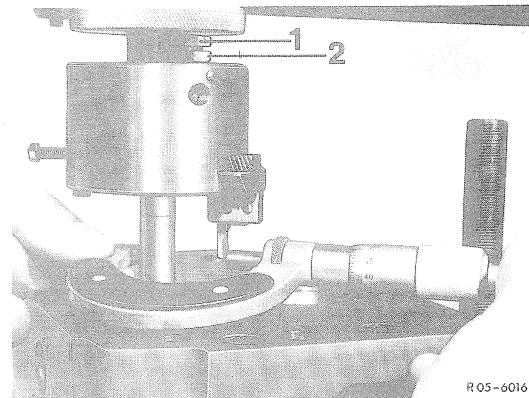

9 Screw horizontal stop screw (1) up to stop against housing, tighten screw (2) located underneath, to protect stop screw against displacement.

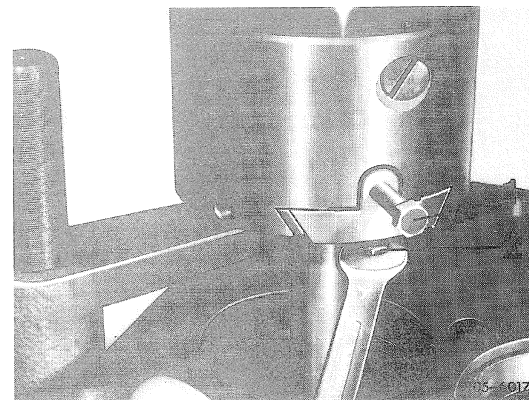

10 By turning hand crank while simultaneously holding upper knurled screw for vertical feed in position, machine bore for valve seat ring until adjusting ring (1) comes to rest against backrest support (2).

Note: Continue adjusting machining bit until adjusting dimension computed under job no. 7 has been attained, then machine once again without additional feed to obtain a roughness of max. 0.006 mm.

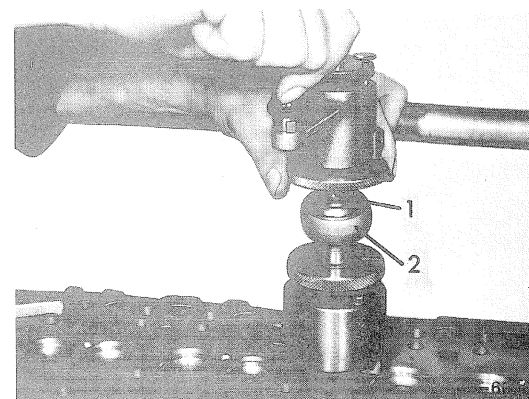

05.11 Renewing valve seat rings (cylinder head and valves removed)

11 Loosen coupling nut, move machining bit back with adjusting screw while lifting machining tool slightly.

12 Machine bottom surface flat by turning hand crank while simultaneously holding bottom knurled disc for horizontal feed in place, until stop screw rests against housing.

14 Remove machining tool. Measure bore with internal measuring instrument 000 589 33 19 00 (overlap between valve seat ring and bore must be assured).

15 Place valve seat rings into undercooling box 346 589 00 63 00 and add liquid oxygen. Undercool valve seat rings for approx. 20–30 minutes.

Note: Liquid oxygen can be obtained from all manufacturers of oxygen.

16 Heat cylinder head in water bath to approx. 80° C.

17 Take valve seat rings out of undercooling box with pliers 000 589 35 37 00, place on bore of heated cylinder head.

18 Install valve seat ring with installation mandrel 346 589 03 15 00.

Note: Do not delay installation of valve seat ring. Fingers should not come into contact with the liquid or the undercooled valve seat ring.

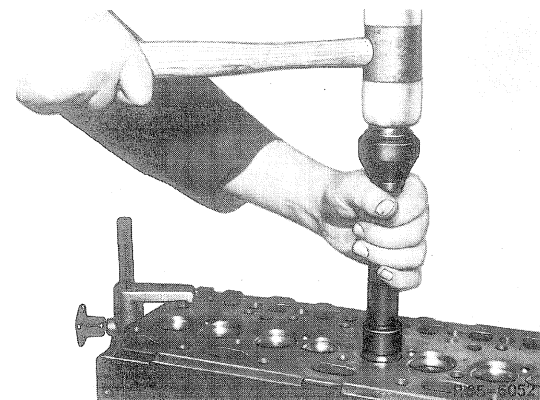
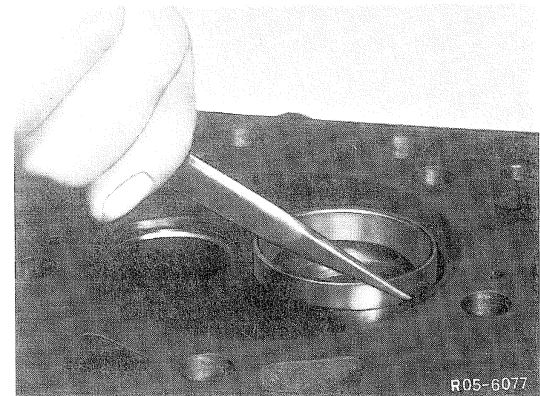
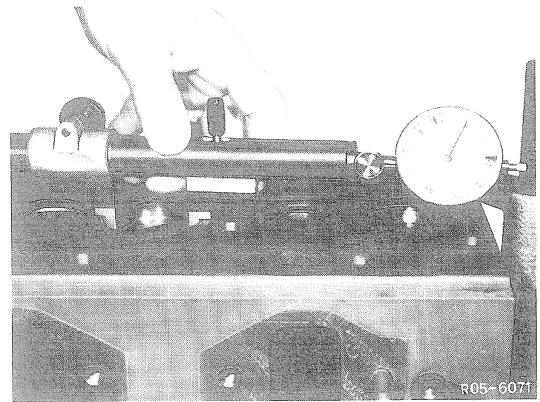

Removal and installation of camshaft 05.11

OM 314

Data

Camshaft and bearing repair stages

Stages	Camshaft bearing	Camshaft journal diameter	Crankpin for air compressor	Finished bore diameter of fitted bearing
Normal	1	<u>55,710</u> 55,691		<u>55,770</u> 55,740
	2	<u>55,460</u> 55,441	<u>32,000</u> 31,984	<u>55,520</u> 55,490
	3	<u>55,210</u> 55,191		<u>55,270</u> 55,240
Normal I	1	<u>55,610</u> 55,591		<u>55,670</u> 55,640
	2	<u>55,360</u> 55,341	<u>31,900</u> 31,884	<u>55,420</u> 55,390
	3	<u>55,110</u> 55,091		<u>55,170</u> 55,140
Repair stage I	1	<u>55,460</u> 55,441		<u>55,520</u> 55,490
	2	<u>55,210</u> 55,191	<u>31,750</u> 31,734	<u>55,270</u> 55,240
	3	<u>54,960</u> 54,941		<u>55,020</u> 54,990
Repair stage II	1	<u>55,210</u> 55,191		<u>55,270</u> 55,240
	2	<u>54,960</u> 54,941	<u>31,500</u> 31,484	<u>55,020</u> 55,990
	3	<u>54,710</u> 54,691		<u>54,770</u> 54,740
Repair stage III	–		<u>31,250</u> 31,234	

Tightening torques in Nm (kpm)

Thrust plate to crankcase	35 (3,5)
Injection timing device to camshaft	300 (30)
Camshaft gear to injection pump drive gear	35 (3,5)

05.11 Removal and installation of camshaft

- 8 Take pulley off crankshaft.
- 9 Unscrew timing gear case cover.

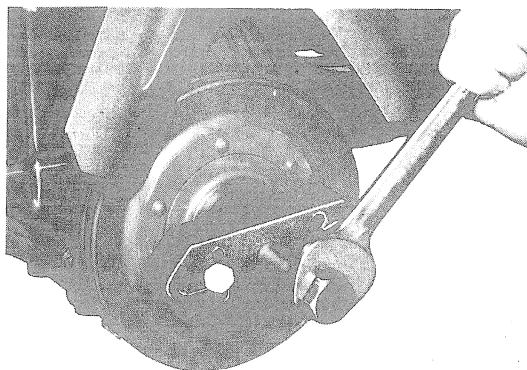

Puller 355 589 00 33 00
Thrust piece 321 589 00 63 00

R03-6031

- 10 Release injection timing device bolt and detach injection timing device.

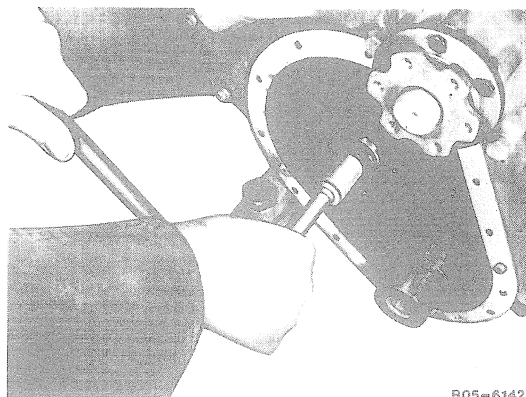

R05-6142

- 11 Take shim of camshaft.

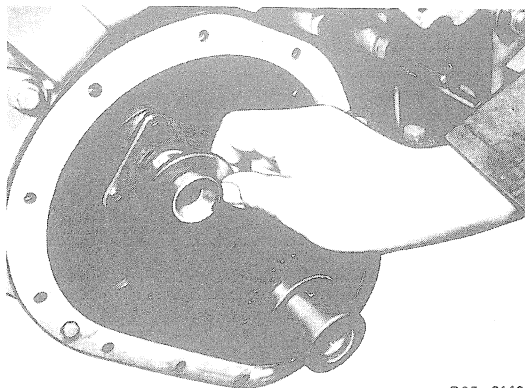

R05-6143

- 12 Unscrew thrust plate and withdraw camshaft from crankcase.

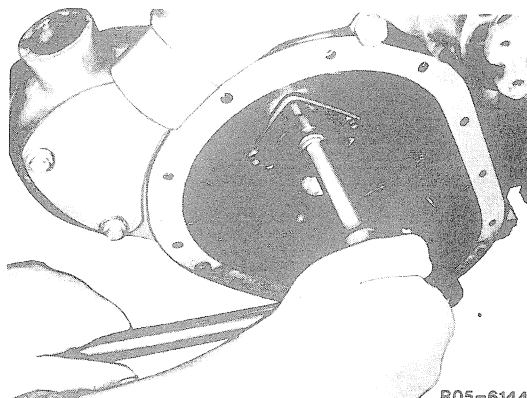

R05-6144

Removal and installation of camshaft 05.11

Installation up to end engine No. 283 201

1 Carefully introduce camshaft into crankcase so as not to damage bearings.

Note: Make sure that the crankshaft gear tooth marked "1" is located between camshaft gear teeth marked "1-1".

2 Tighten thrust plate without tab washer.

3 Attach timing gear case cover.

4 Mount pulley on crankshaft.

5 Install oil pump.

6 Bolt oil pan in position.

7 Install air compressor.

8 Insert tappets and pushrods.

9 Attach pushrod cover.

10 Fit rocker arms.

11 Adjust valve clearance.

12 Attach cylinder head cover.

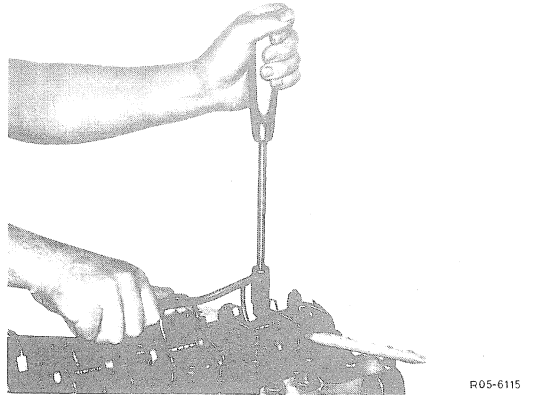
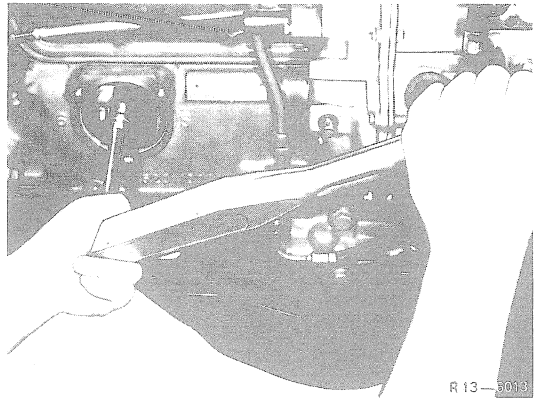
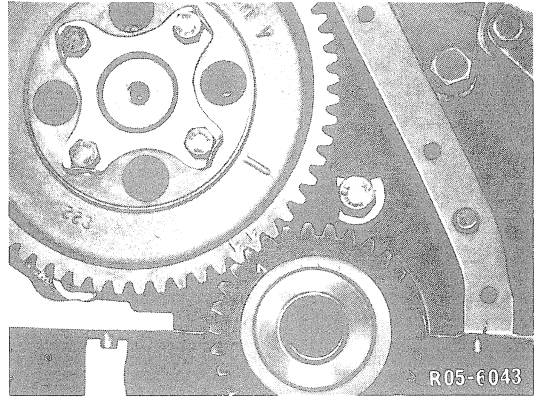

Installation from end engine No. 283 202

1 Carefully introduce camshaft into crankcase so as not to damage bearings.

2 Fasten thrust plate, torquing to 35 Nm with torque wrench.

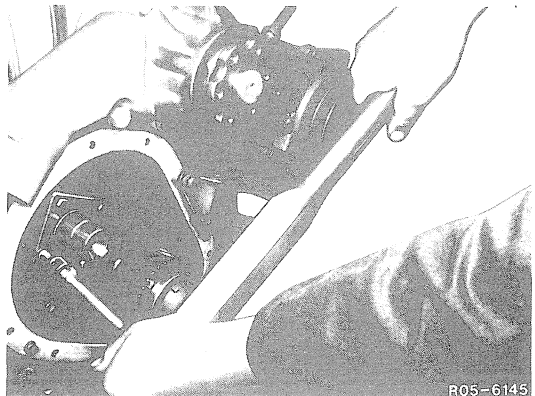

05.11 Removal and installation of camshaft

3 Position shim on camshaft.

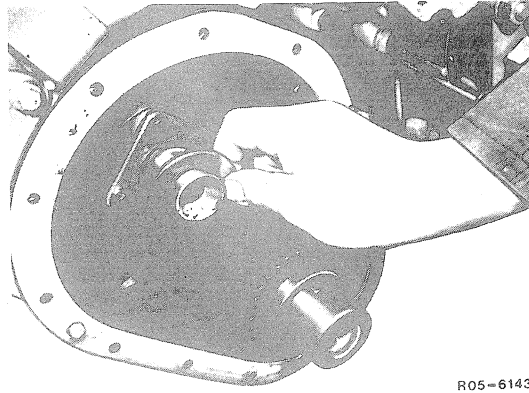

R05-6143

4 Fix injection timing device on camshaft with feather key and insert fastening bolt.

Note: Make sure that crankshaft gear tooth marked "1" is located between injection timing device teeth marked "1-1".

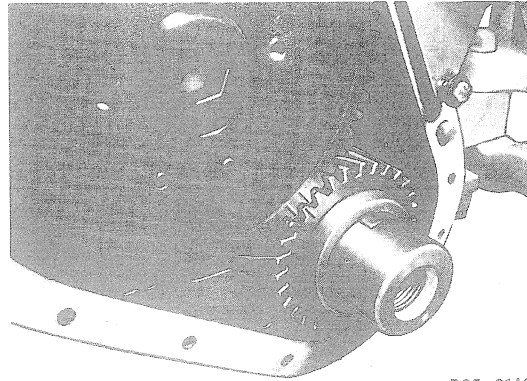

R05-6146

5 Tighten fastening bolt for injection timing device, torquing to 300 Nm with torque wrench.

6 Attach timing gear case cover.

7 Mount pulley on crankshaft.

8 Install oil pump.

9 Bolt oil pan in position.

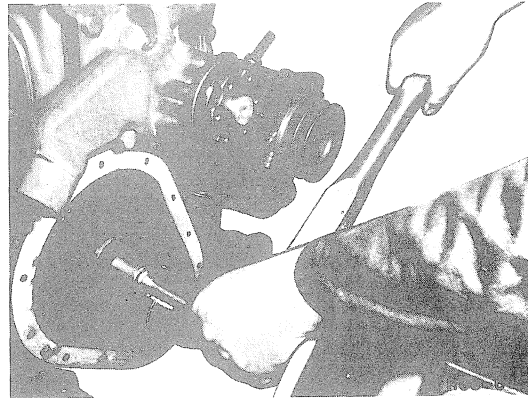

10 Install air compressor.

11 Fit tappets and pushrods.

12 Attach pushrod cover.

13 Fit rocker arms.

14 Adjust valve clearance.

15 Attach cylinder head cover.

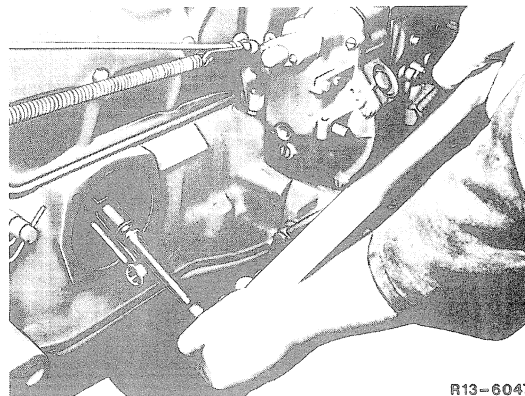

R13-6047

07.11 Exploded views

OM 314

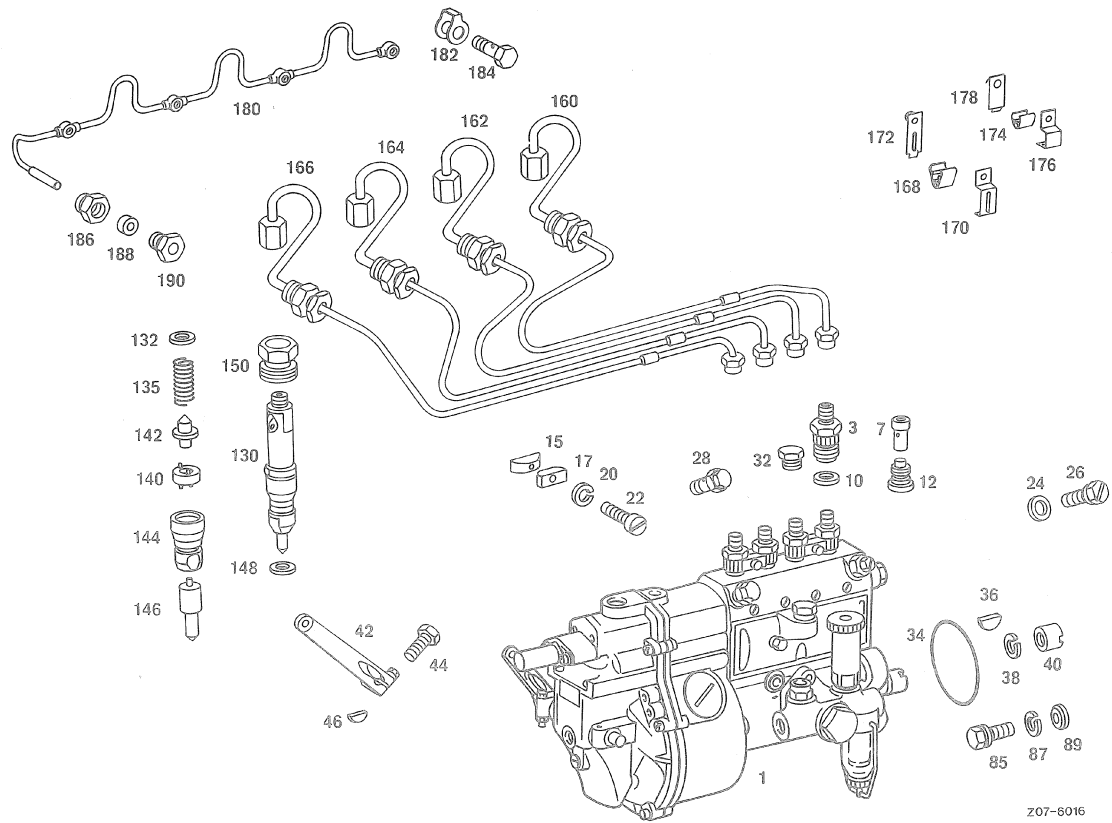

Z07-6016

Injection

1 Injection pump	40 Nut	160 Line
3 Screw connection	42 Lever	162 Line
7 Insert	44 Screw	164 Line
10 Sealing ring	46 Woodruff key	166 Line
12 Pressure valve	85 Screw	168 Shim
15 Shim	87 Snap ring	170 Clamp
17 Shim	89 Washer	172 Clamp shim
20 Snap ring	130 Nozzle holder	174 Shim
22 Screw	132 Spacing washer	176 Clamp
24 Sealing ring	135 Compression spring	178 Clamp shim
26 Screw	140 Spacing washer	180 Line
28 Pressure valve	142 Bolt	182 Seal
32 Closing plug	144 Cap nut	184 Hollow screw
34 Sealing ring	146 Nozzle	186 Closing plug
36 Woodruff key	148 Sealing ring	188 Sealing ring
38 Snap ring	150 Screw	190 Closing plug



Transporters volume 1



Engines volume 2 - supplement 2 - revision - December 1977

005/1

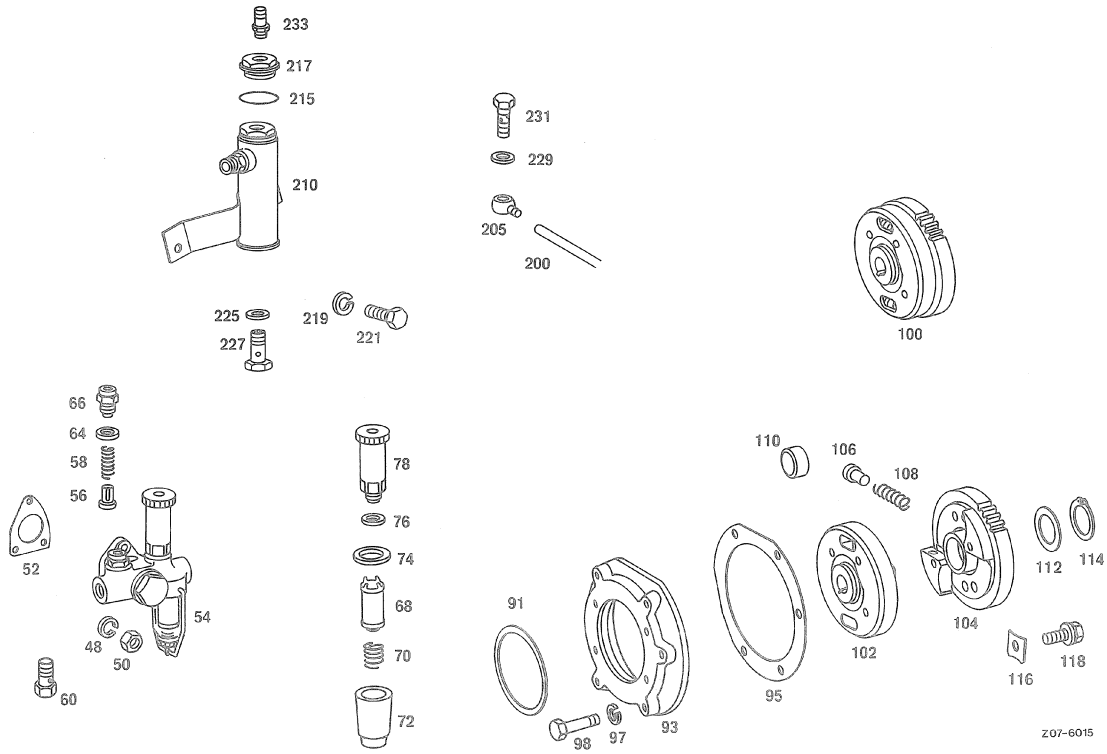

Injection

48 Snap ring	78 Fuel pump	116 Locking ring
50 Nut	91 Sealing ring	113 Screw
52 Gasket	93 Carrier	200 Hose
54 Fuel pump	95 Gasket	205 Ring fitting
56 Valve	97 Snap ring	210 Vent
58 Valve spring	98 Screw	215 Sealing ring
60 Screw	100 Injection timer	217 Screw connection
64 Sealing ring	102 Segment	219 Snap ring
66 Ring fitting	104 Drive gear	221 Screw
68 Strainer	106 Bolt	225 Sealing ring
70 Spring	108 Spring	227 Hollow screw
72 Filter housing	110 Regulator weight	229 Sealing ring
74 Sealing ring	112 Spacing washer	231 Hollow screw
76 Sealing ring	114 Locking ring	233 Hollow screw

07.11 Injection pumps

OM 314

Installation survey

Engine type	Injection pump Bosch designation (MB part no.)	Governor Bosch designation	Delivery pump Bosch designation	Test values DAI sheet Date
OM 314, up to October 1966				
(80 HP)	PES 4 A 80 C 410 RS 2094 (005 074 91 01)	RQV 300 ... 1425 AB 564 DL	FP/KS 22 AD 6/4	DAI 3.8 a 4.68
	PES 4 A 80 C 410 RS 2094 (007 074 17 01)	RQV 300 ... 1425 AB 579 DL	FP/KS 22 AD 6/4	DAI 3.8 a 4.68
	PES 4 A 80 C 410 RS 2094 (007 074 20 01)	RQV 300 ... 1000/1425 AB 578 DL	FP/KS 22 AD 6/4	DAI 3.8 a 4.68
OM 314, starting October 1966				
(80 HP)	PES 4 A 80 C 410 RS 2206 (007 074 80 01)	RQV 300 ... 1425 A 564 DL	FP/KS 22 AD 23/2	DAI 3.8 a 4.68
	PES 4 A 80 C 410 RS 2206 (007 074 98 01)	RQV 300 ... 1425 AB 623 DL	FP/KS 22 AD 23/2	DAI 3.8 a 4.68
	PES 4 A 80 C 410 RS 2206 (007 074 96 01)	RQV 300 ... 1425 AB 624 DL	FP/KS 22 AD 23/2	DAI 3.8 a 4.68
OM 314, starting January 1968				
(80 HP)	PES 4 A 80 C 410 RS 2244 (A) (008 074 81 01)	RQV 300 ... 1425 AB 564 DL	FP/KS 22 AD 23/2	DAI 3.8 a 4.68
	PES 4 A 80 C 410 RS 2244 (A) (008 074 95 01)	RQV 300 ... 1425 AB 623 DL	FP/KS 22 AD 23/2	DAI 3.8 a 4.68
	PES 4 A 80 C 410 RS 2244 (A) (008 074 93 01)	RQV 300 ... 1425 AB 624 DL	FP/KS 22 AD 23/2	DAI 3.8 a 4.68
OM 314, starting September 1969				
(85 HP)	PES 4 A 90 $\frac{5}{8}$ 410 RS 2294 (010 074 89 01)	RQV 300 ... 1425 AB 740 L	FP/KS 22 AD 23/2	MB 3.8 g 2nd edition
	PES 4 A 90 $\frac{5}{8}$ 410 RS 2294 (011 074 02 01)	RQV 300 ... 1425 AB 781 L	FP/KS 22 AD 23/2	MB 3.8 g 2nd edition
	PES 4 A 90 $\frac{5}{8}$ 410 RS 2294 (011 074 04 01)	RQV 300 ... 1425 AB 780 L	FP/KS 22 AD 23/2	MB 3.8 g 2nd edition



07.11 Test values for injection pump and governor

OM 314, 80 HP

(Bosch injection pump test sheet DAI 3,8 a dated April 68)

Injection pump: PES 4 A 80 C 410 RS 2094, RS 2206 (A), RS 2244 (A)

Governor: RQV 300-1425 AB 564 DL, 579 DL

RQV 300-1000/1425 AB 578 DL

A. Adjustment values for injection pump

Begin of delivery at pre-lift $2.15 + 0.1$ mm (from BTC)

1	2	3
Speed 1/min	Rack travel mm	Injection rate cc/100 strokes
1000	6	2.4- 3.2
	9	5.7- 6.2
	15	11.7-13.0
200	6	1.4- 2.3

Adjust delivery of equal quantities according to boxed values

B. Adjustment values for governor RQV 300-1425 AB 564 DL, 579 DL

1	2	3	4	5	6	7	8	9	10	11
Top rated speed			Mean rated speed			Bottom rated speed			Adaptation	
Deflec- tion of adjust- ing lever Degrees	RT		Deflec- tion of adjusting lever Degrees	RT		Deflec- tion of adjusting lever Degrees	RT		1/min	mm
	1/min	mm		1/min	mm		1/min	mm		
66±1.5	1425 1450 1550 1650 1750 1800	16.0-19.3 14.6-18.2 8.2-13.3 1.3- 8.0 0 - 2.5 0				10±1.5	100 250 400 500 600 770	7.0-8.0 5.5-7.0 3.5-5.2 2.5-3.7 1.4-2.8 0		

Adaptation travel dimension a = 0 mm

C. Adjustment values for injection pump with governor attached

	1	2	3	4	5	6	7	8
Test oil tempe- rature	Full load quantity on governor control lever		Rack stop	Delivery characteristics		Starting qty.		Intermediate speed
	1/min	cc/1000 str.	1/min	1/min	cc/1000 str.	1/min	mm RT	1/min
20° C	800	49.5-51.5	1470: 0.5-1.0 mm RT less than column 2	1400 500	59.7-63.7 43.5-47.5	100	13-14	564 DL = -- 578 DL = 700 579 DL = 1300
40° C	800	48.5-50.5		1400 500	57.6-61.5 42.5-46.5			



07.11

B. Adjustment values for governor RQV 300–1000/1425 AB 578 DL

1	2	3	4	5	6	7	8	9	10	11
Deflection of adjusting lever Degrees	Top rated speed		Mean rated speed			Bottom rated speed			Adaptation	
	1/min	RT mm	Deflection of adjusting lever Degrees	1/min	RT mm	Deflection of adjusting lever Degrees	1/min	RT mm	1/min	RT mm
68 ± 1.5	1400	12.0–15.4	62 ± 1.5	1000	12.0-14.6	10 ± 1.5	200	7.8–8.0		
	1450	8.0–12.5		1100	5.2- 8.2		300	6.0–6.8		
	1500	3.4– 9.6		1200	5.2- 5.6		350	5.0		
	1550	0 – 6.6		1400	1.7- 4.8		400	3.2–3.9		
	1660	0		1490	0		600	0.8–2.0		
							740	0		

Adaptation travel dimension a = 0 mm

07.11 Test values for injection pump and governor

OM 314, 85 HP

Bosch injection pump test sheet MB 3,8 g – 2nd edition

Injection pump: PES 4 A 90 § 410 RS 2294

Governor: RQV 300–1425 AB 740 L, 780 L, 781 L

A. Adjusting values of injection pump

Begin of delivery at pre-lift 2.15 + 0.1 mm (from BDC)

1	2	3	4	5		6
Speed	Rack travel	Injection rate	Difference	Rack travel	Injection rate	Spring preload (adaptation valve)
1/min	mm	cc/100 str.	cc/100 str.	mm	cc/100 str.	mm
1000	6	2.0–2.8	0.4			
	9	4.7–5.2				
	12	7.5–8.4				
200	9	2.1–2.9				

Adjust for uniform delivery according to boxed-in data

B. Adjusting values of governor RQV 300–1425 AB 740 L

1	2	3	4	5	6	7	8	9	10	11
Deflection of adjusting lever Degrees	Top rated speed		Mean rated speed			Bottom rated speed			Sleeve travel Adaptation	
	1/min	RT	Deflection of adjusting lever Degrees	1/min	RT	Deflection of adjusting lever Degrees	1/min	RT	1/min	ST mm RT mm
		mm								
approx. 66	1425	16.0–19.4				approx. 10	100	6.6–7.8	400 1425	1.4–2.2 8.1
	1500	11.6–16.0				300	4.9–6.4			
	1550	8.2–13.4				450	3.0–4.2			
	1650	1.4– 8.0				600	1.3–2.8			
	1790	0				760	0			

Adaptation travel dimension a = 0 mm

C. Adjusting values of injection pump with governor attached

	1	2	3	4	5	6	7	8
Test oil temperature	Full load quantity on governor control lever		Rack stop	Delivery characteristics		Starting qty.		Intermediate speed
	1/min	cc/1000 str.	1/min	1/min	cc/1000 str.	1/min	cc/100 str.	1/min
40° C	1400	65.0–67.0	1475–1485 ¹⁾			100	appr. 8	
						Switch point 250–180/min		

For checking, increase values (column 2 and 5) by ± 1 cc.

¹⁾ 1 mm rack travel less than column 2!

07.11

B. Adjusting values of governor RQV 300—1425 AB 780 L RQV 300—1425 AB 781 L

1	2	3	4	5	6	7	8	9	10	11
Deflection of adjusting lever Degrees	Top rated speed		Mean rated speed			Bottom rated speed			Sleeve travel Adaptation	
	1/min	RT mm	Deflection of adjusting lever Degrees	1/min	RT mm	Deflection of adjusting lever Degrees	1/min	RT mm	1/min	ST mm RT mm
approx. 68	1425 1500 1600 1650 1790	16.0–19.0 10.8–15.3 3.3–10.0 0 – 7.4 0				approx. 10	100 300 450 600 770	6.0–7.4 4.9–6.6 3.0–3.9 1.4–2.8 0	400 1425	1.2–2.2 8.3

Adaptation travel dimension a = 0 mm

C. Adjusting values of injection pump with governor attached

	1	2	3	4	5	6	7	8
Test oil temperature	Fuel load quantity on governor control lever		Rack stop	Delivery characteristics		Starting qty.		Intermediate speed
	1/min	cc/1000 str.	1/min	1/min	cc/1000 str.	1/min	cc/100 str.	1/min
40° C	1400	65.0–67.0	1475–1485 ¹⁾			100	approx. 8	780 L = 700 781 L = 1300
						Switch point 250–180/min		

¹⁾ 1 mm rack travel less than column 2!

07.11 Adjustment of injection pump in relation to engine

OM 314

Data

Begin of delivery	80 HP ¹⁾	21° BTDC
	85 HP ²⁾	15° BTDC

¹⁾ up to engine end no. 051 952

²⁾ Starting engine end no. 051 953

Tightening torques in Nm (kpm)

Pipe connection for delivery valve ("D" version)	35 (3.5)
Pipe connection for delivery valve ("C" version)	45 (4.5)
Coupling nut of injection line	25 (2.5)

Note: To provide a perfect seat of pipe connection, tighten connection to specified torque – loosen again – (do not screw out) and tighten once more to specified torque.

Special tools

Special wrench for injection line	000 589 07 03 00
Torque wrench 20–100 Nm (2–10 kpm)	000 589 64 21 00
Container for adjusting injection pump	000 589 05 23 00
Pipe with nipple	636 589 02 23 00

Adjustment of injection pump

- 1 Remove cylinder head cover.
- 2 Set engine at compression stroke in direction of rotation according to mark on pulley and in alignment with indicator on timing housing to begin of delivery (FB). Do not turn back.

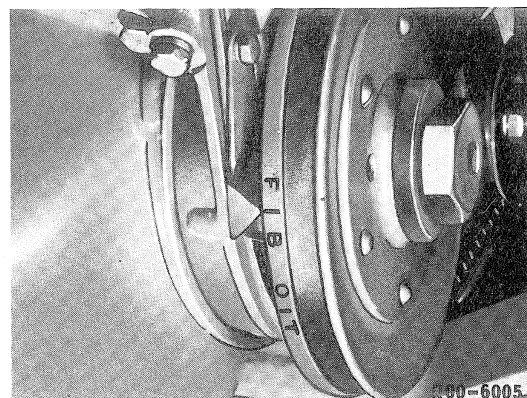

Transporters volume 1



Engines volume 2 – supplement 2 – revision – December 1977

07.11

Note: A double indicator is fitted starting engine end no. 051 953.

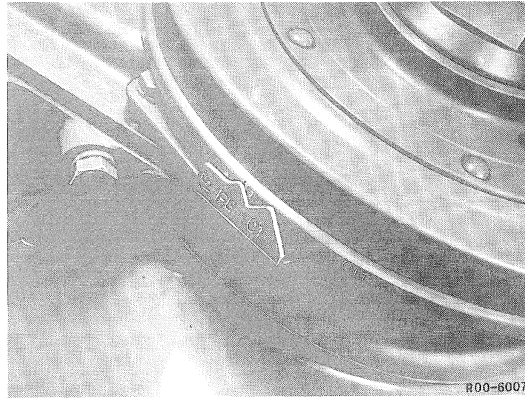

3 Remove oil filler pipe from injection timer housing.

4 Check marks on segment plate of injection timer and drive gear for alignment. Simultaneously, notch on tip of tooth should be in alignment with arrow. If markings are not accurately in alignment, a light push with a hammer handle or an aluminum mandrel against gear wheel will be enough. The fly weights will then move into zero position. If no alignment is attained, remove injection pump and check injection timer.

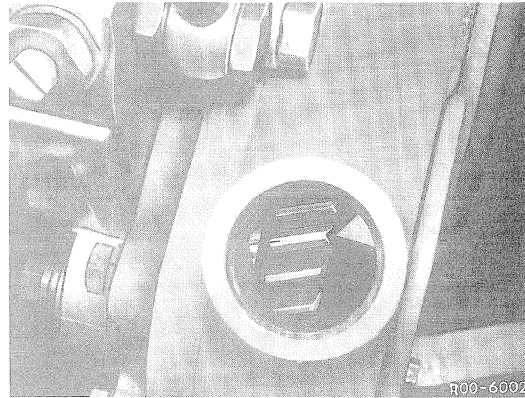

5 Unscrew injection line for 1st cylinder from injection pump by means of special wrench 000 589 07 03 00.

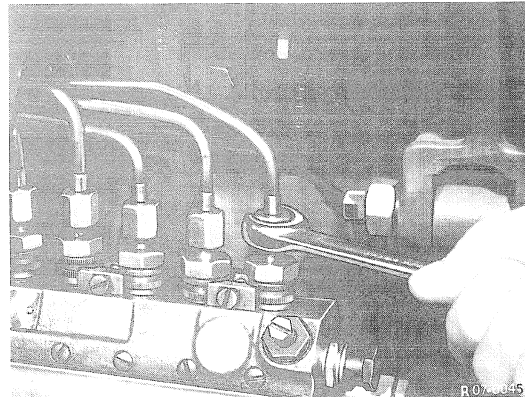

6 Unscrew pipe connection from 1st cylinder of injection pump and remove filler, compression spring and valve cone.

7 Reinstall pipe connection and screw-on small overflow pipe.

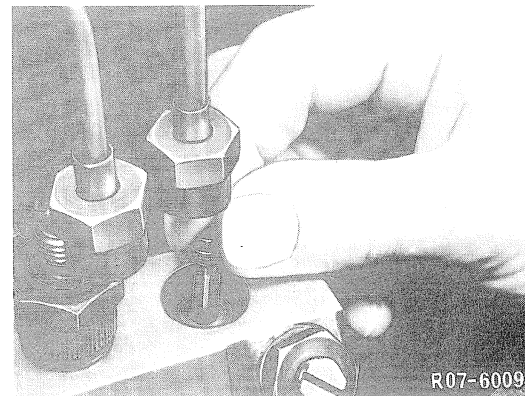

07.11 Adjustment of injection pump in relation to engine

8 Unscrew fuel supply line from injection pump and attach container 000 589 05 23 00.

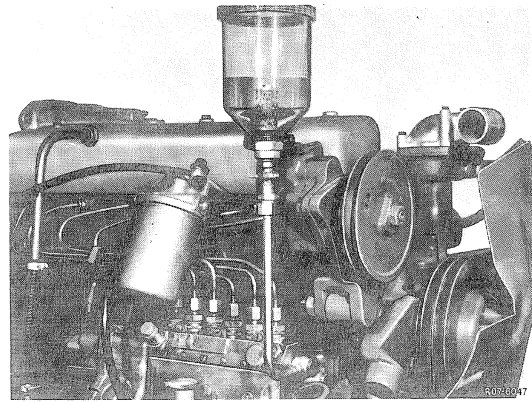

9 Fill container with clean fuel and open shutoff valve. Set regulating lever on injection pump to full load.

10 If correctly adjusted, **one drop** of fuel should flow out of overflow pipe 15–20 sec. apart. If too much fuel is flowing out or no drops are starting to fall, loosen injection pump fastening screws and swivel injection pump in slots laterally to the extent that accurate adjustment is attained. For this purpose, unscrew all injection lines and reinstall free of tension following position adjustment.

Note: If the swivel range of the injection pump is no longer enough, adjustments can also be made by means of slots on drive gear of injection pump. Remove kidney-shaped closing cover on timing housing for this purpose.

11 Remove container and small overflow pipe.

12 Screw fuel supply line to injection pump.

13 Unscrew pipe connection from 1st cylinder of injection pump and reattach together with filler, compression spring and valve cone.

14 Screw injection line back to 1st cylinder of injection pump free of tension.

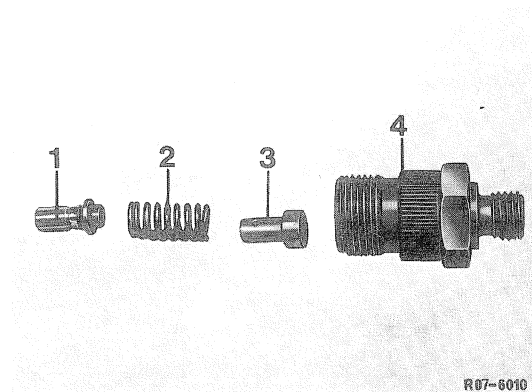

- 1 Valve cone
- 2 Compression spring
- 3 Filler
- 4 Pipe connection



07.11 Removal of injection pump

OM 314

Special tools

Special wrench for injection lines	000 589 07 03 00
Special wrench for guide tube of oil dipstick	314 589 00 09 00
Slot nut wrench	322 589 00 09 00
Internal puller	000 589 27 33 00
Puller	355 589 00 33 00
Countersupport	000 589 33 34 00

Removal

- 1 Remove oil filler neck from timing housing.
- 2 Set engine to begin of delivery.
- 3 Unscrew coupling nuts of injection lines with special wrench 000 589 07 03 00 from injection pump.
- 4 Unscrew fuel line from delivery pump and injection pump.
- 5 Unscrew oil supply line.
- 6 Unscrew guide tube of oil dipstick from cylinder head and from cylinder crankcase with special wrench 314 589 00 09 00 and remove.

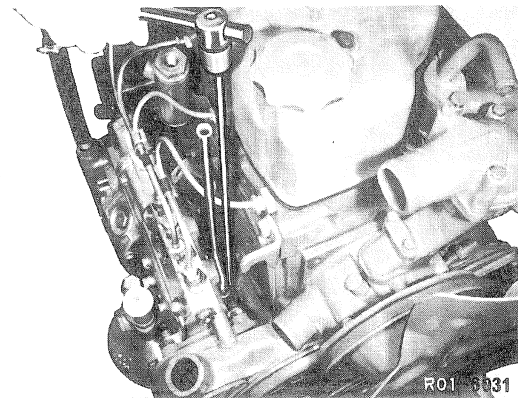
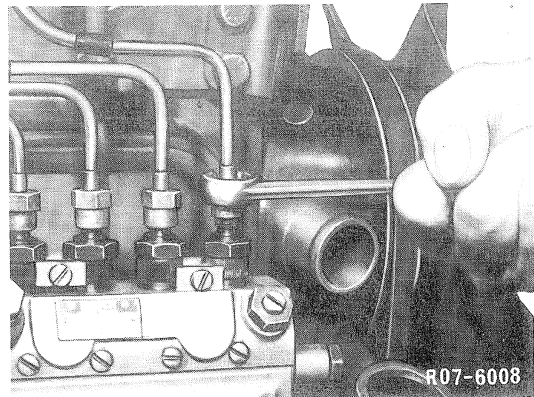

07.11

7 Unscrew injection pump with carrier from timing housing and remove.

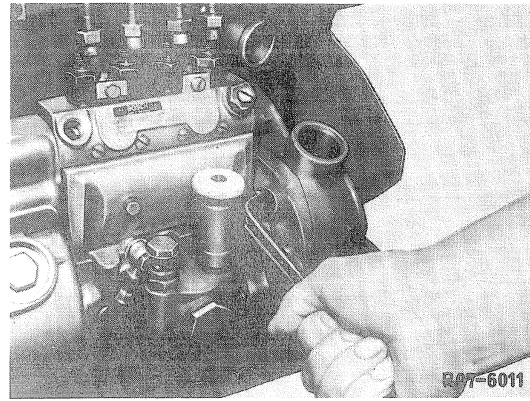

8 Unscrew slot nut with slot nut wrench 322 589 00 09 00.

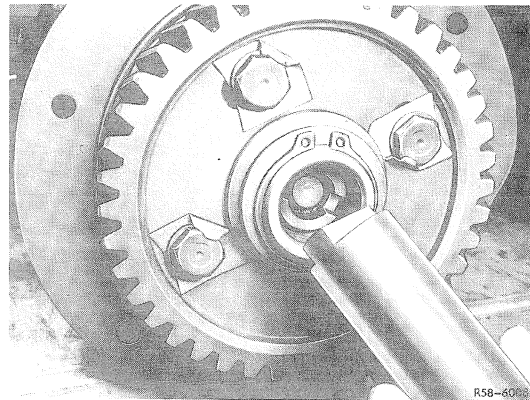

9 Loosen locking plates for injection pump gear and remove screws.

10 Loosen screws from injection pump at cover.

11 Pull injection timer from injection pump with puller 355 589 00 33 00.

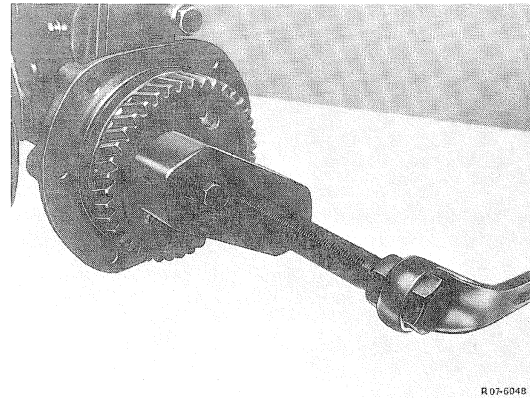

Note: Starting engine end no. 247 662 the injection timer is pulled from injection pump with internal puller 000 589 27 33 00 and countersupport 000 589 33 34 00.

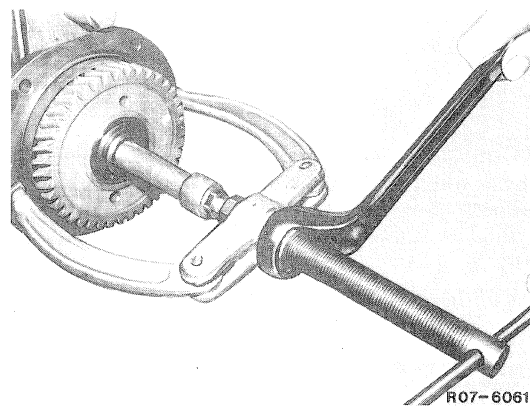

07.11 Installation of injection pump

OM 314

Data

Begin of delivery	at 80 HP	21° BTDC
	at 85 HP	15° BTDC

Tightening torque in Nm (kpm)

Coupling nut of injection line	25 (2.5)
--------------------------------	----------

Special tools

Special wrench for injection lines	(SW 17)	000 589 68 03 00
Special wrench for injection lines	(SW 19)	346 589 00 03 00
Special wrench for guide tube of oil dipstick		314 589 00 09 00
Torque wrench 20–100 Nm (2–10 kpm)		000 589 64 21 00

Installation

- 1 Attach injection timer and carrier to injection pump.
- 2 Set engine to begin of delivery at ignition TDC of 1st cylinder.
- 3 Insert injection pump with new gasket in timing housing in such a manner that the tooth of the injection pump gear marked with a notch is in alignment with arrow in timing housing. Tighten injection pump.
- 4 Adjust begin of delivery.
- 5 Tighten guide tube of oil dipstick on cylinder head and on crankcase with special wrench 314 589 00 09 00.
- 6 Screw fuel line to delivery pump and injection pump.

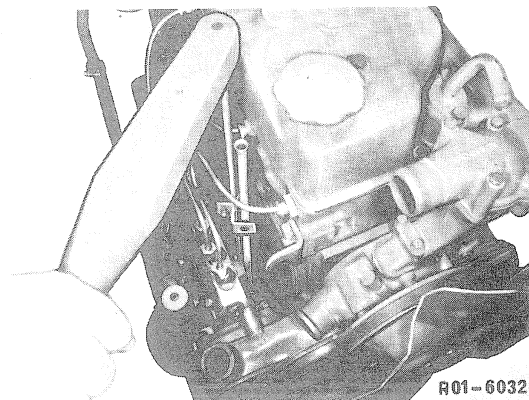
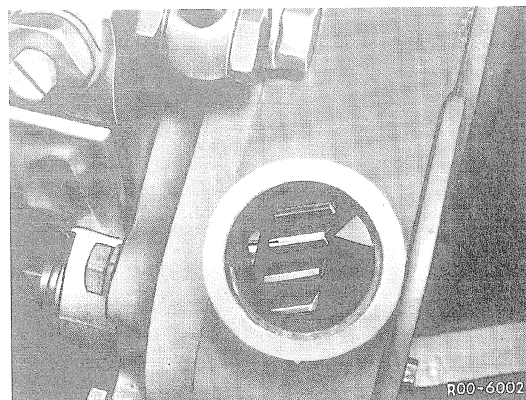

07.11

7 Tighten coupling nut of injection lines with special wrench 000 589 07 03 00 or 346 589 00 03 00 and torque wrench 000 589 64 21 00 to pipe connections of injection pump.

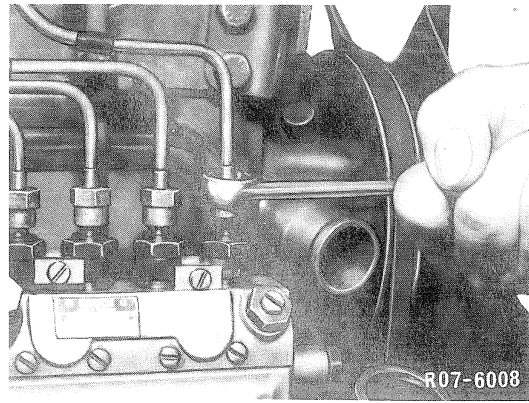

07.11 Removal and installation of nozzle holder and protective sleeve

OM 314

Data

Nozzle holder	KDAL 74 S 3/19
---------------	----------------

Tightening torques in Nm (kpm)

Cylinder head cover	25 (2.5)
Coupling nut injection line	25 (2.5)
Pressure screw nozzle holder	60–70 (6–7)
Protective sleeve in cylinder head	60 (6)

Special tools

Special wrench for injection lines	000 589 07 03 00
Special wrench for protective sleeve	346 589 00 07 00
Socket for pressure screw	000 589 75 09 00
Special wrench	346 589 00 13 00
Torque wrench 20–100 Nm (2–10 kpm)	000 589 64 21 00
Puller for nozzle holder	352 589 00 33 00
Impact tool	355 589 01 63 00

Removal

- 1 Remove cylinder head cover.
- 2 Unscrew coupling nut of injection line from injection pump with special wrench 000 589 07 03 00.

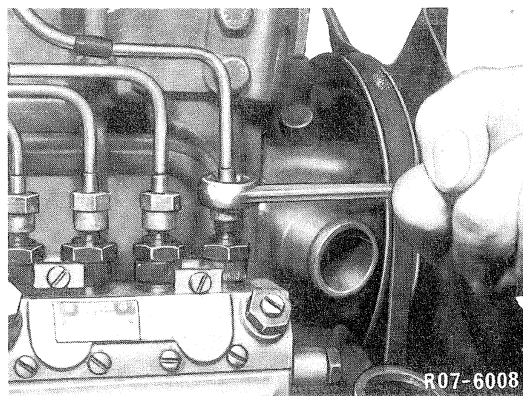

07.11

3 Unscrew coupling nut of injection line from nozzle holder with special wrench 000 589 07 03 00 and remove injection line.

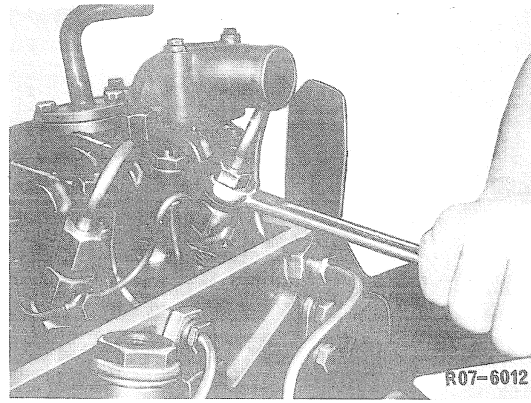

Note: Make sure that injection lines are never bent out of shape.

4 Unscrew leak oil line.

5 Unscrew pressure screw for nozzle holder with socket 000 589 75 09 00.

6 Knock nozzle holder out of cylinder head with impact tool 355 589 01 63 00.

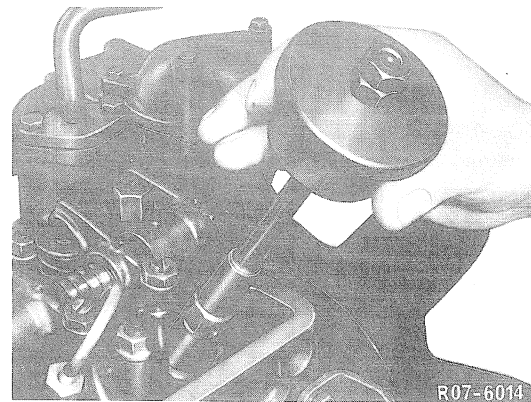

or pull out with puller 352 589 00 33 00.

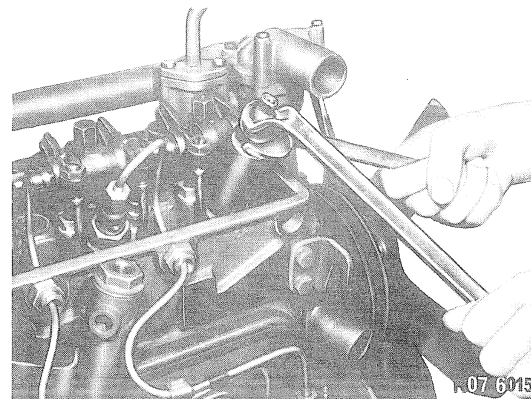

07.11 Removal and installation of nozzle holder and protective sleeve

7 Insert special wrench 346 589 00 07 00 into cylinder head.

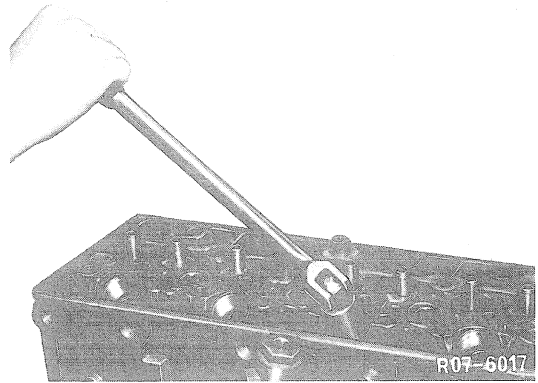

8 Screw protective sleeve out of cylinder head.

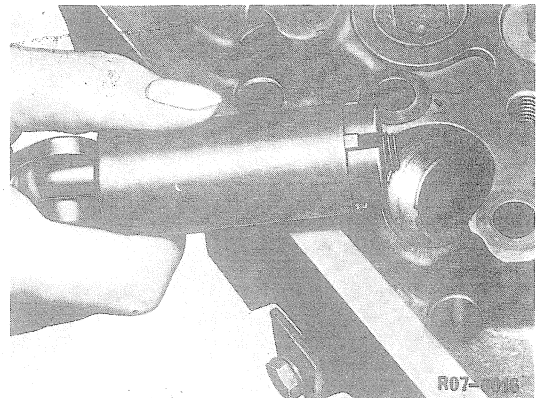

Installation

1 Insert new sealing ring for protective sleeve into cylinder head.

2 Screw protective sleeve into cylinder head with special wrench 346 589 00 07 00 and torque wrench 000 589 64 21 00.

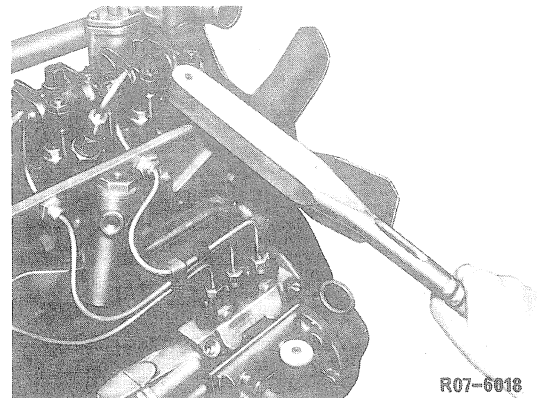

3 Insert new seal for nozzle holder into protective sleeve.

4 Introduce nozzle holder with nozzle into cylinder head, while paying attention to lock on nozzle holder and groove in cylinder head.

Attention: Do not knock against nozzle!

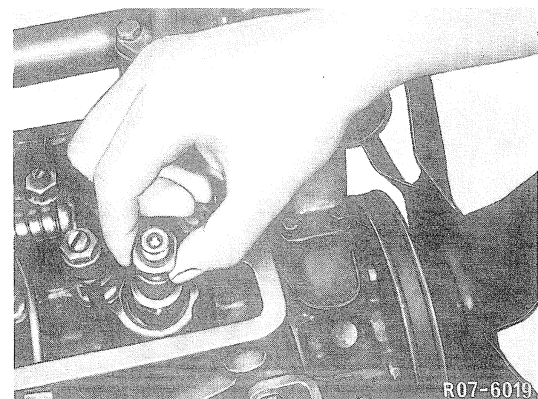

07.11

5 Screw-in pressure screw for nozzle holder by means of socket 000 589 75 09 00 and tighten to specified torque.

6 Install leak oil line with new sealing brackets.

7 Install injection line and screw to injection pump and nozzle holder.

8 Place cylinder head cover with new gasket on cylinder head and tighten with torque wrench 000 589 64 21 00.

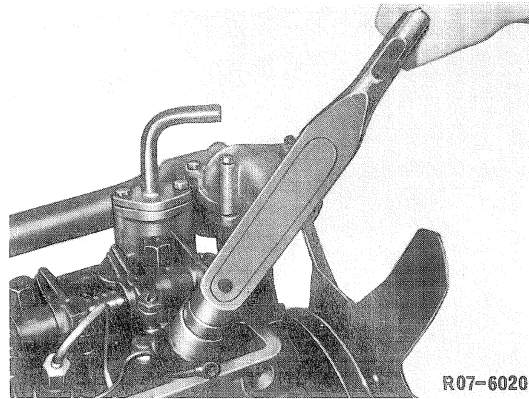

Note: With injection lines installed, tighten pressure screw for nozzle holder with special wrench 346 589 00 13 00.

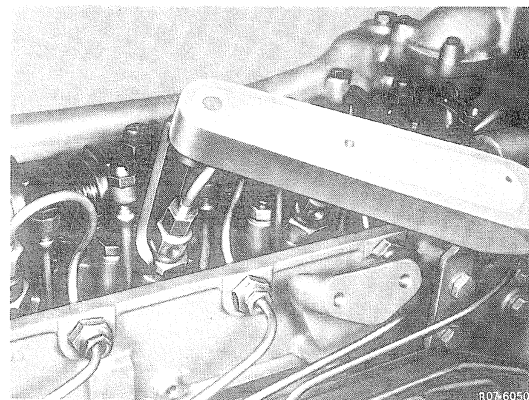

07.11 Inspection of injection nozzle

OM 314

Data

Injection nozzles		DLLA 150 S 187
Ejection pressure	new nozzles	200 + 10 bar (kp/cm ²)
	used nozzles	min. 180 bar (kp/cm ²)

Note: However, the pressure difference of nozzles within one engine should not exceed 10 bar (kp/cm²).

Special tools

Nozzle tester	000 589 14 27 00
---------------	------------------

Checking injection nozzle for leaks

- 1 Carefully remove coke residue on nozzle.
- 2 Screw nozzle with nozzle holder to nozzle tester 000 589 14 27 00.

Note: For testing, use clean test oil or filtered diesel oil only. When testing a nozzle, **never permit hand to come into contact with jet of an ejecting nozzle**. The jet will enter deeply into flesh and will destroy the tissue. Fuel entering the blood stream may cause blood poisoning.

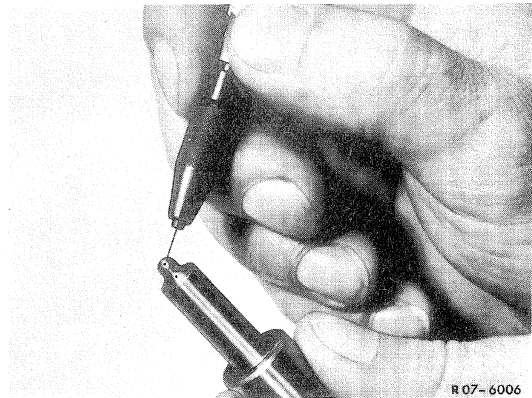

- 3 Slowly push pump lever down until lever on pressure gauge is 20 bar (kp/cm²) below preset opening pressure. The nozzle is leaktight, if no drop comes out of nozzle mouth within 10 seconds.

- 4 In the event of leak, disassemble ejection nozzle and clean.

Note: If a leak cannot be repaired by careful cleaning of seat surfaces at nozzle body and nozzle needle, replace nozzle.

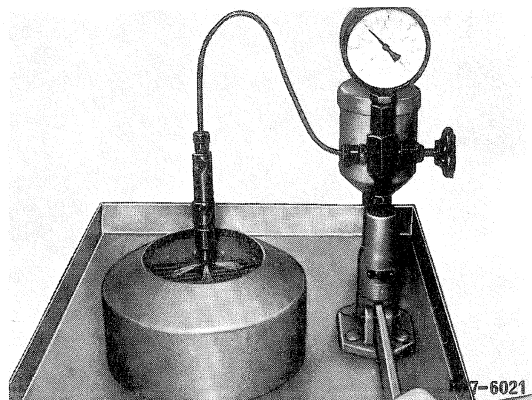

07.11

Checking opening or ejection pressure of injection nozzle

1 Push hand pump lever of nozzle tester, with pressure gauge connected, slowly (1 stroke per second) down and read opening pressure when nozzle opens and ejection begins.

Note: With pressure gauge set, increase pressure only slowly and above all reduce pressure only slowly, since otherwise the pressure gauge may suffer damage.

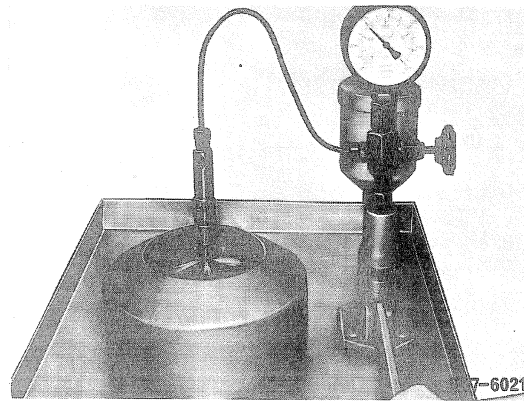

2 If the ejection pressure is too high or too low, disassemble injection nozzle, clean and set correctly.

Jet test

1 Switch off pressure gauge.

2 Push hand pump lever of nozzle tester down four to six times per second. Nozzle will buzz very softly. Atomization is in order if the four jet cones are uniformly closed, finally atomized, without lateral streamers. Minor ranges without buzzing and with non-atomized "cord-like" jets are without significance.

Note: The test oil will come out as a non-atomized cord-like jet until buzzing range is attained.

07.11 Disassembly and assembly of nozzle holder and injection nozzle (nozzle holder removed)

OM 314

Tightening torques in Nm (kpm)

Nozzle to nozzle holder	80 (8)
-------------------------	--------

Special tools

Special wrench for disassembly and assembly of nozzle holder	000 589 01 13 00
Torque wrench 20–100 Nm (2–10 kpm)	000 589 64 21 00
Mounting for nozzle holder	403 589 00 31 00
Bosch nozzle cleaner	000 589 00 68 00

Disassembly and assembly

1 Insert nozzle holder into mounting 403 589 00 31 00.

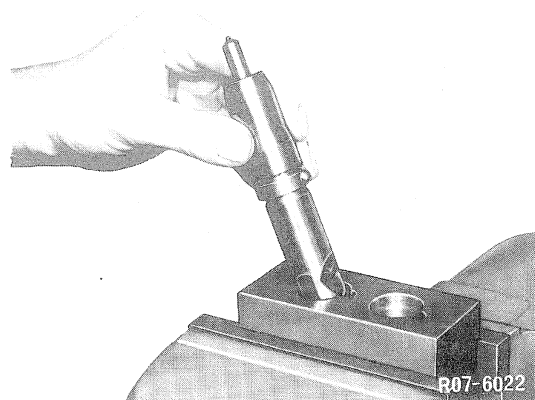

2 Unscrew pressure nut from nozzle body with special wrench 000 589 01 13 00. Disassemble nozzle.

3 Clean disassembled nozzle externally and internally, in particular the needle seat and the ring groove, by means of a wooden stick and diesel fuel.

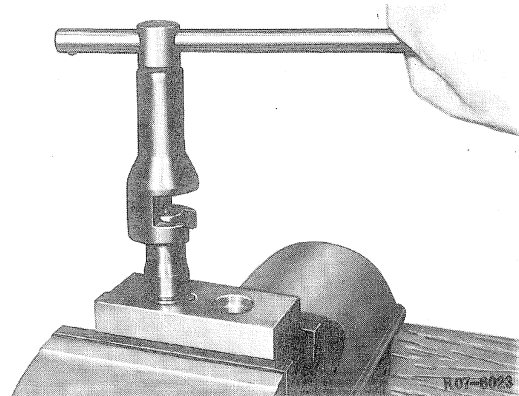

07.11

4 Clean injection bores of nozzle body with a cleaning needle from nozzle cleaner 000 589 00 68 00.

5 Immerse nozzle needle and nozzle body in clean diesel fuel and check for easy sliding by means of drop test.

Drop test: When the nozzle needle pulled out of nozzle body by one third of its length is released, needle should slide down to its seat under its own weight. If not, replace nozzle and nozzle body.

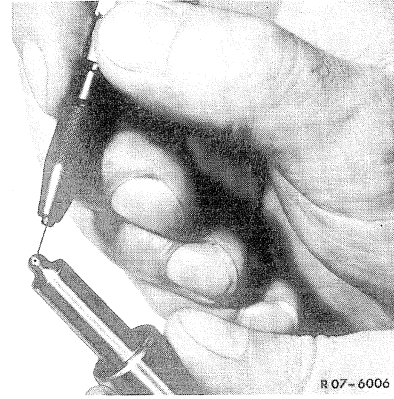

6 Assemble nozzle. Pay attention to locating pin on intermediate washer.

Note: If the nozzle test shows that the ejection pressure is too high or too low, install pertinent washer (item 2).

When the pressure is too high, use a thinner washer, when it is too low, a thicker washer.

- | | |
|----------------------|--|
| 1 Nozzle holder | 5 Intermediate washer with locating pins |
| 2 Washer | 6 Nozzle |
| 3 Compression spring | 7 Nozzle body |
| 4 Pressure pin | 8 Pressure nut |

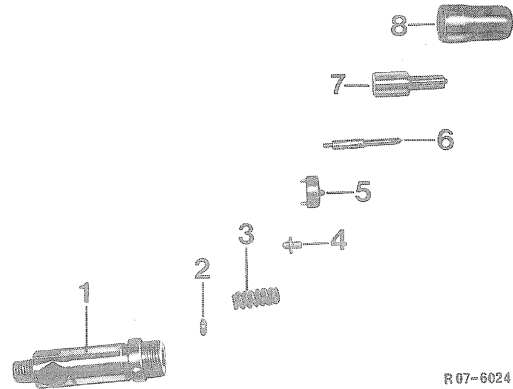

7 Insert nozzle holder into mounting 403 589 00 31 00.

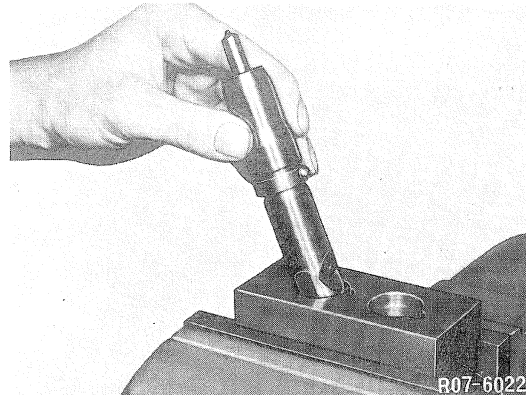

8 Tighten pressure nut with special wrench 000 589 01 13 00 and torque wrench 000 589 64 21 00.

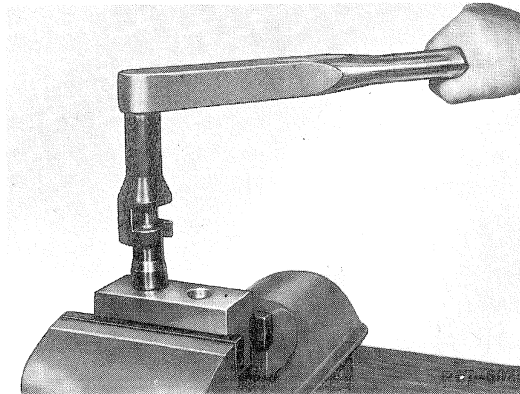

13.11 Removal and disassembly of air compressor

OM 314, air compressor 77 mm dia.

Special tools

Socket wrench	312 589 09 07 00
Special wrench	321 589 02 07 00
Piston ring pliers	000 589 37 37 00

Removal and disassembly of air compressor

- 1 Remove intake hose and pressure line.
- 2 Unscrew cylinder head and remove together with gasket.
- 3 Unscrew cylinder liner and pull off over piston.

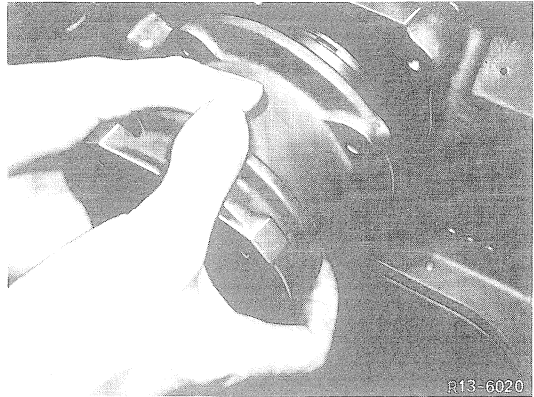

- 4 Unlock piston pin.
- 5 Push out piston pin and remove together with piston.

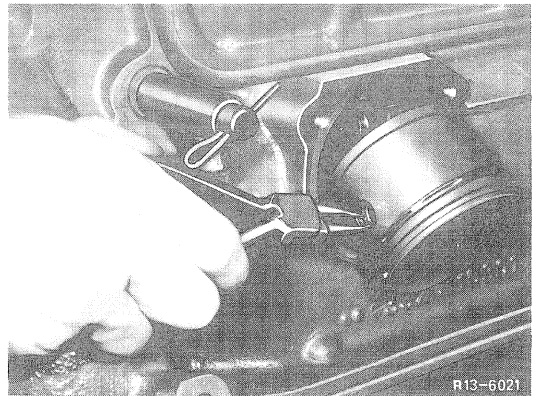

- 6 Unscrew connecting rod and remove with connecting rod cap and bearing shells.

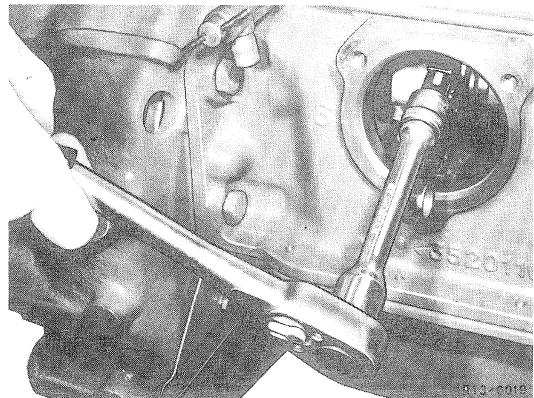

13.11

7 Screw suction valve cap out of cylinder head by means of special wrench 321 589 02 07 00. Remove valve spring, valve disc and suction valve seat.

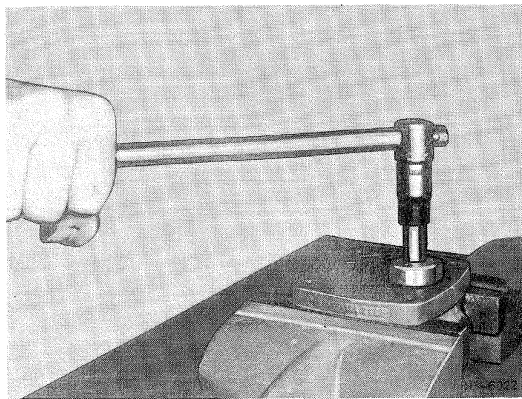

8 Screw pressure valve seat out of cylinder head with socket wrench 312 589 09 07 00 and remove together with valve disc, valve spring and spring housing.

9 Remove piston rings from piston with piston ring pliers 000 589 37 37 00.

10 Wash all parts with benzine.

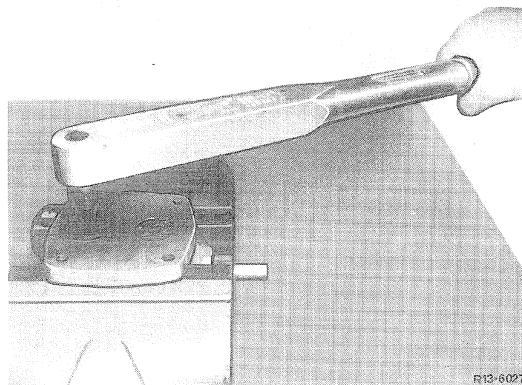

13.11 Removal and disassembly of air compressor

OM 314, air compressor 94 mm dia.

Special tools

Special wrench	352 589 03 07 00
Piston ring pliers	000 589 37 37 00

Removal and disassembly of air compressor

- 1 Remove intake hose and pressure line.
- 2 Unscrew cylinder liner with cylinder head and remove cylinder head with gasket.
- 3 Pull off cylinder liner over piston.

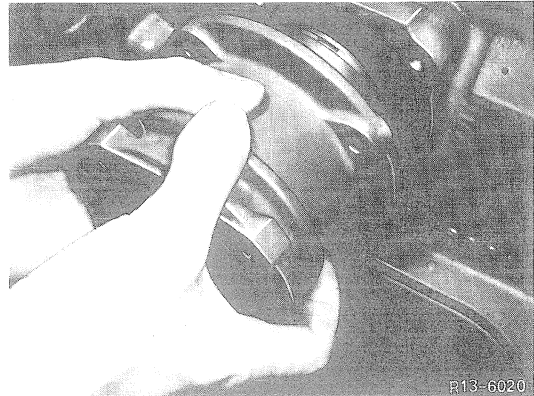

- 4 Unlock piston pin.
- 5 Push out piston pin and remove together with piston.

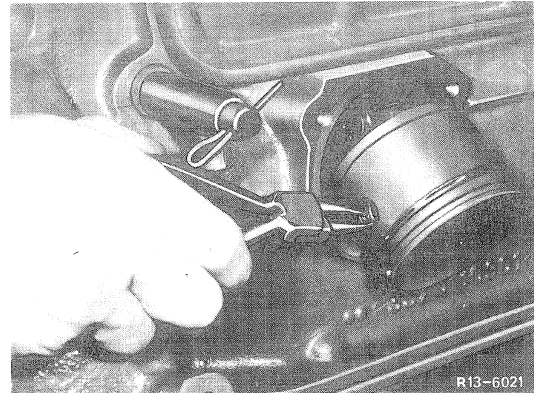

- 6 Unscrew connecting rod and remove together with connecting rod cap and bearing shells.

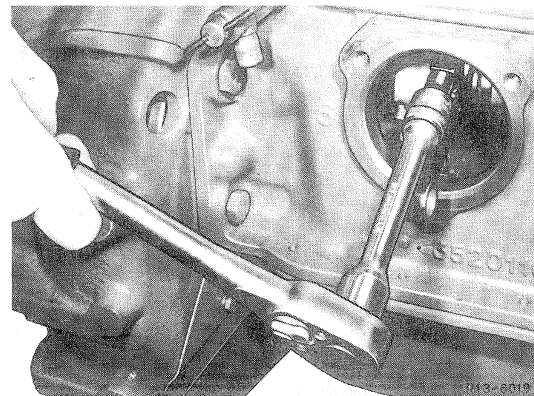

13.11

7 Screw suction valve cap from cylinder head with special wrench 352 589 03 07 00. Remove valve disc, screw washers; 2nd valve disc and suction valve seat.

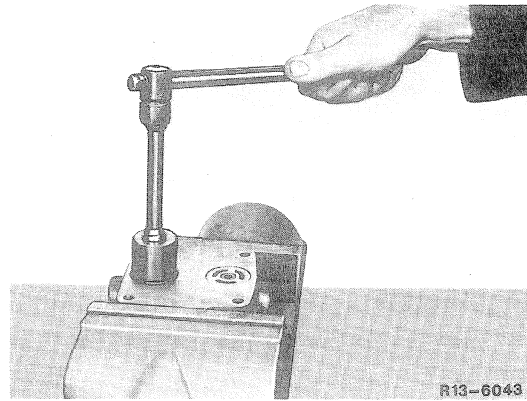

8 Loosen cap nut and remove complete pressure valve from cylinder head.

9 Disassemble pressure valve.

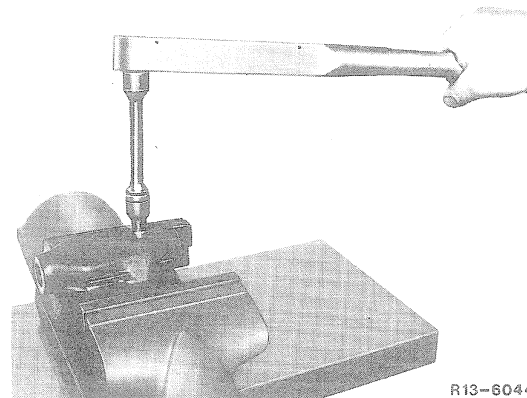

10 Remove piston rings from piston with piston ring pliers 000 589 37 37 00.

11 Clean all parts with benzine.

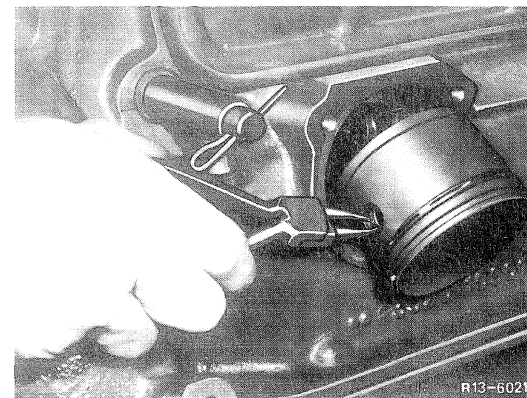

13.11 Mounting and installation of air compressor

OM 314

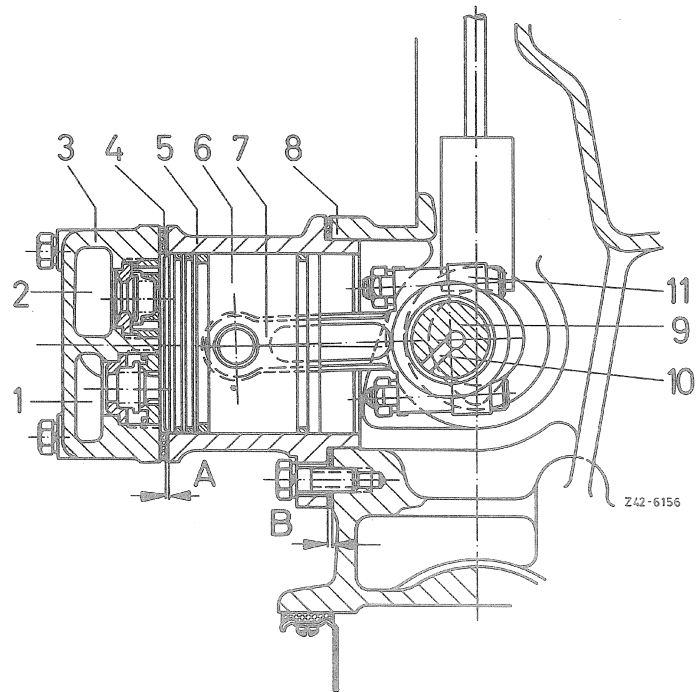

Single-cylinder air compressor

- | | | |
|------------------------------|-------------------------------|---|
| 1 Compressed air outlet duct | 7 Connecting rod | A Piston with screwed-on cylinder liner |
| 2 Intake duct | 8 Engine-crankcase | 0.1–0.3 mm projecting (standing out) |
| 3 Cylinder head | 9 Camshaft crank pin | at cylinder liner |
| 4 Cylinder head gasket | 10 Oil duct in camshaft | B Gasket 0.25 and 0.5 mm thick |
| 5 Cylinder liner | 11 Connecting rod bearing cap | |
| 6 Piston | | |

Data

Bore	77	94
Stroke	30	30
Total displacement	140 cc	208 cc
Delivery volume 1/min at engine nominal speed	85	130
Max. operating pressure	7.35 or 8.1 ²⁾ bar (kp/cm ²)	8.1 bar (kp/cm ²)
Filling time in seconds at engine governing speed with new air compressor and 40 l tank	from 0 to 7.35 bar	170 ¹⁾
	from 0 to 8.1 bar	

¹⁾ The max. still permissible filling time amounts to approx. 30% more than the time measured with new air compressor.

²⁾ Starting chassis end No. 1.4–282.708.



13.11

Cylinder liner and piston

Nominal dia.	77 mm		94 mm	
Rep. stages	Bore dia.	Piston dia.	Bore dia.	Piston dia.
Normal	<u>77.015</u>	<u>76.995</u>	<u>94.015</u>	<u>93.895</u>
	76.985	76.965	93.985	93.865
Normal I	<u>77.090</u>	<u>77.070</u>	<u>94.090</u>	<u>93.970</u>
	77.060	77.040	94.060	93.940
Normal II	<u>77.140</u>	<u>77.120</u>	<u>94.140</u>	<u>94.020</u>
	77.110	77.090	94.110	93.990
I. rep. stage	<u>77.265</u>	<u>77.245</u>	—	—
	77.235	77.215		
II. rep. stage	<u>77.515</u>	<u>77.495</u>	—	—
	77.485	77.465		
Piston clearance	0.010–0.030		0.11–0.13	

Note: Always install piston and piston liner with uniform class ratings.

Piston rings for nominal dia. 77 mm

Groove	Piston ring designation	Width of groove	Side clearance	Gap clearance
I	Tapered compression ring	2.5 + 0.020	0.010–0.044	0.30–0.45
II	Tapered compression ring	2.5 + 0.020	0.010–0.044	0.30–0.45
III	Baffle ring	3.0 + 0.020	0.010–0.044	0.30–0.45
IV	Chamfered oil ring	4.0 + 0.020	0.010–0.044	0.25–0.40

Note: Up to engine end No. 190 106, the chamfered oil ring of groove IV had been installed in groove III and the baffle ring of groove III into groove IV. The piston ring grooves were made in accordance with piston ring assembly. The oil bores in groove for oil wiper ring are eliminated starting engine end No. 190 107.

The pistons of the new version can be exchanged for pistons of the former version complete with rings.

Piston rings for nominal dia. 94 mm

Groove	Piston ring designation	Width of groove	Gap clearance
I	Baffle ring	<u>2.503</u>	0.40–0.65
		2.501	
II	Baffle ring	<u>2.503</u>	0.40–0.65
		2.501	
III	Baffle ring	<u>2.503</u>	0.40–0.65
		2.501	

13.11 Mounting and installation of air compressor

Connecting rod

Nominal dia.	77	94
Basic bore in connecting rod	<u>35.016</u>	<u>35.016</u>
	35.000	35.000
Basic bore for connecting rod bushing	<u>19.021</u>	<u>19.021</u>
	19.000	19.000
Distance from center of camshaft crank pin to center of piston pin bore	<u>92.000</u>	<u>97.000</u>
	91.950	96.950
Permissible deviation of axially parallel alignment for 100 mm in length	0.03	0.03
Width of connecting rod at	connecting rod eye	<u>21.935</u>
		21.883
piston pin eye	<u>22.3</u>	<u>27.935</u>
	22.2	27.883
Radial play of connecting rod bearing journals	0.030–0.066	0.030–0.066
Axial play of connecting rod bearing journals	0.065–0.317	0.065–0.317

Camshaft crank pin and connecting rod bearing

Stages	77		94	
	Crank pin dia.	Bearing bore in installed condition	Crank pin dia.	Bearing bore in installed condition
Normal	<u>32.000</u>	<u>32.050</u>	<u>32.000</u>	<u>32.050</u>
	31.984	32.040	31.984	32.040
Normal I	<u>31.900</u>	<u>31.950</u>	<u>31.900</u>	<u>31.950</u>
	31.884	31.940	31.884	31.040
Rep. stage I	<u>31.750</u>	<u>31.800</u>	<u>31.750</u>	<u>31.800</u>
	31.734	31.790	31.734	31.790
Rep. stage II	<u>31.500</u>	<u>31.550</u>	<u>31.500</u>	<u>31.550</u>
	31.484	31.540	31.484	31.540
Rep. stage III	<u>31.250</u>	<u>31.300</u>	<u>31.250</u>	<u>31.300</u>
	31.234	31.290	31.234	31.290

Connecting rod bushing

Nominal dia.	77	94
OD	<u>19.048</u>	<u>19.048</u>
	19.035	19.035
ID	<u>16.035</u>	<u>16.035</u>
	16.025	16.025
Overlap of connecting rod bushing in connecting rod	0.014–0.048	0.014–0.048
Length of connecting rod bushing		<u>27.8</u>
		27.6



13.11

Piston pin

Compressor dia.	77	94
Piston pin OD	<u>16.015</u>	<u>16.015</u>
	16.012	16.012
Bore in piston	<u>16.022</u>	<u>16.045</u>
	16.018	16.041
Piston pin clearance in connecting rod bushing	0.010–0.023	0.010–0.023
Piston pin clearance in piston	0.003–0.010	0.026–0.033
Length of piston pin	<u>66.00</u>	<u>66.00</u>
	65.70	65.70

Tightening torques in Nm (kpm)

Nominal dia.	77	94
Connecting rod	15+2 (1.5+0.2)	15+2 (1.5+0.2)
Cylinder liner to crankcase	35–40 (3.5–4)	–
Cylinder head to liner	35–40 (3.5–4)	–
Suction valve in cylinder head	100–120 (10–12)	180±20 (18±2)
Pressure valve in cylinder head	100–120 (10–12)	10±1 (1±0.1)
Preassembly pressure valve	–	22±2 (2.2±0.2)
Cylinder head and cylinder liner to cylinder crankcase	–	30 (3)

Special tools

Socket wrench	312 589 09 07 00
Special wrench	321 589 02 07 00
Special wrench	352 589 03 07 00
Torque wrench 0–60 Nm (0–6 kpm)	000 589 27 21 00
Torque wrench 80–300 Nm (8–30 kpm)	001 589 39 21 01
Piston ring pliers	000 589 37 37 00
Pliers	321 589 00 37 00
Clamping strap	321 589 01 37 00

13.11 Mounting and installation of air compressor

Mounting and installation of air compressor 77 mm dia.

- 1 Insert bearing shells into connecting rod and connecting rod bearing cap.
- 2 Screw connecting rod bearing cap to connecting rod.
- 3 Set internal measuring instrument 18–35 mm dia. with micrometer 25–50 mm dia. and measure bore vertically at 3 points and each time approx. 30° from separating points.
- 4 Unscrew connecting rod bearing cap.
- 5 Measure connecting rod bushing ID with internal measuring instrument 10–18 mm dia. Adjust internal measuring instrument accordingly with micrometer 0–25 mm dia.
- 6 Screw connecting rod with bearing shells and bearing cap to camshaft crank pin.

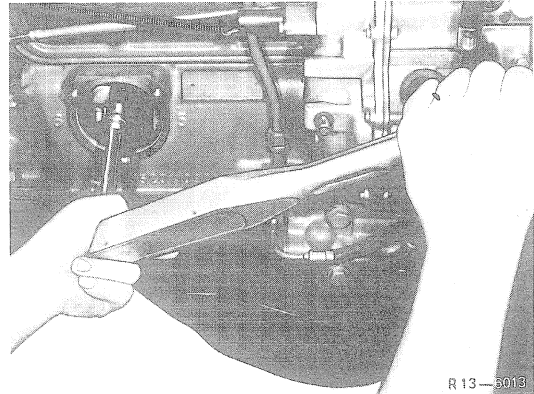

- 7 Mount piston rings on piston with piston ring pliers 000 589 37 37 00.
- 8 Position piston against connecting rod and install piston pin.
- 9 Secure piston ring with locking ring.

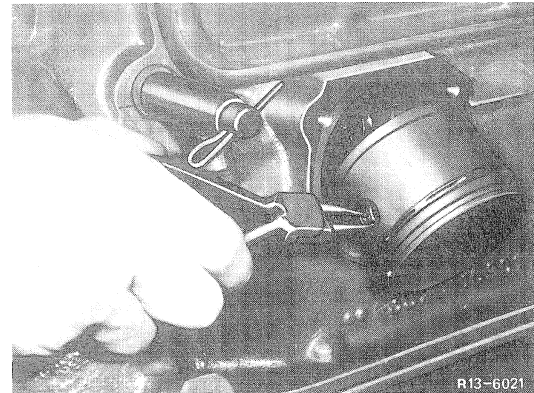

- 10 Compress piston rings with clamping strap 321 589 01 37 00 and pliers 321 589 00 37 00 to outer dia. of piston. Mount cylinder liner with gasket over piston.
- 11 Screw cylinder liner to crankcase.

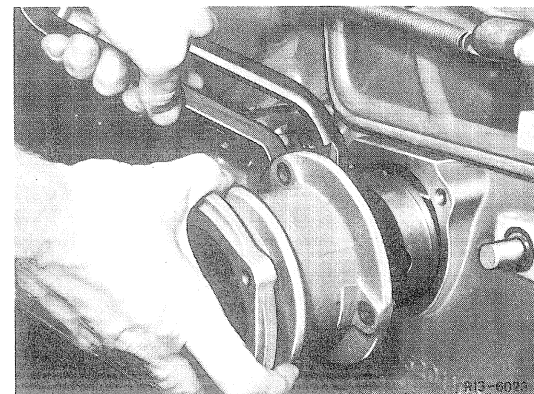

13.11

12 Insert suction valve components in sequence of suction valve seat (4), valve disc (3), valve spring (2) and suction valve cap (1) into cylinder head.

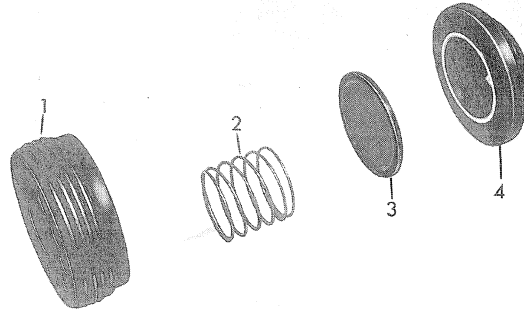

R 13-6014

13 Tighten suction valve cap with special wrench 000 589 02 07 00 and torque wrench 001 589 39 21 01.

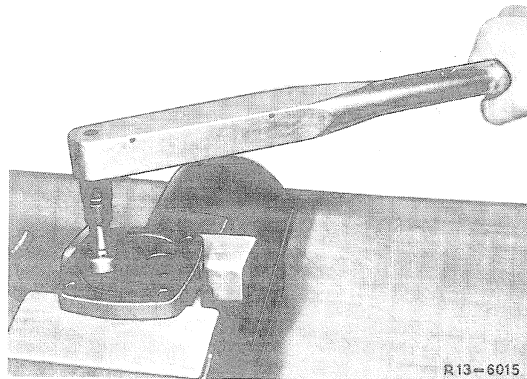

R13-6015

14 Insert pressure valve components in sequence of pressure valve seat (4), valve disc (3), valve spring (2) and spring housing (1) into cylinder head.

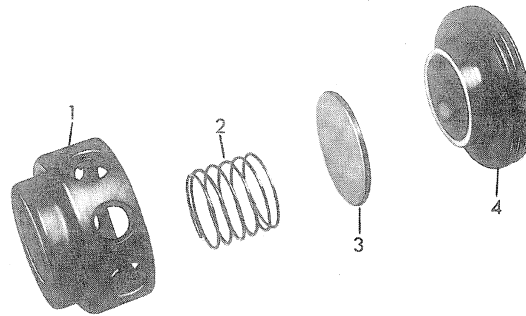

R13-6016

15 Tighten pressure valve with socket wrench 312 589 09 07 00 and torque wrench 001 589 39 21 01.

16 Screw cylinder head with new gasket to cylinder liner.

17 Install intake hose and pressure line.

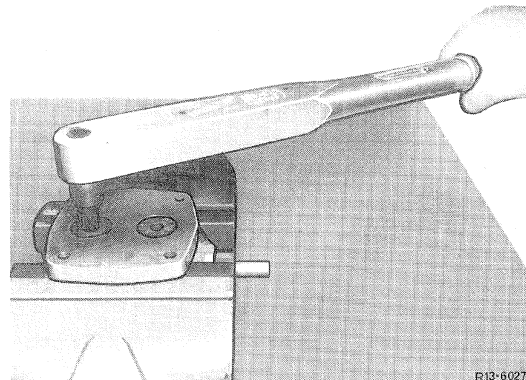

R13-6027

13.11 Mounting and installation of air compressor

Mounting and installation of air compressor 94 mm dia.

- 1 Insert bearing shells into connecting rod and connecting rod bearing cap.
- 2 Screw connecting rod bearing cap to connecting rod.
- 3 Adjust internal measuring instrument 18–35 mm dia. with micrometer 25–50 mm dia. and measure bore at 3 points vertically and each time approx. 30° away from separating points.
- 4 Unscrew connecting rod bearing cap.
- 5 Measure connecting rod bushing ID with internal measuring instrument 10–18 mm dia. For this purpose, adjust internal measuring instrument with micrometer 0–25 mm dia.
- 6 Screw connecting rod with bearing shells and bearing cap to camshaft crank pin.

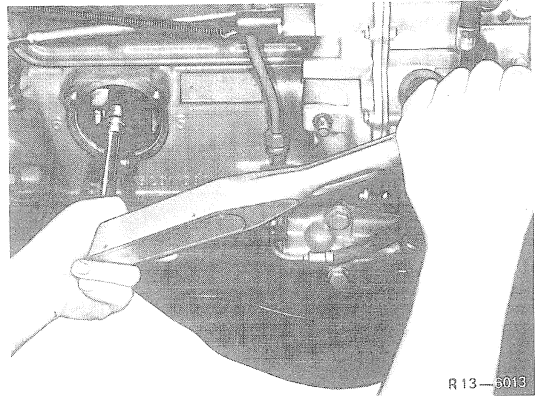

- 7 Mount piston rings on piston with piston ring pliers 000 589 37 37 00.
- 8 Position piston against connecting rod and install piston pins.
- 9 Secure piston pins.

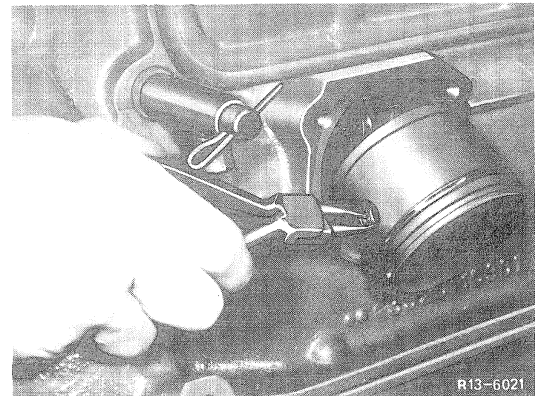

- 10 Preassemble pressure valve, insert into cylinder head and tighten cap nut with torque wrench 000 589 27 21 00.

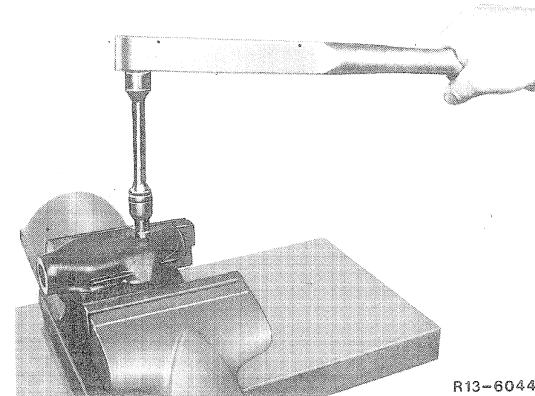

13.11

11 Insert suction valve in sequence of valve seat, valve disc (without bore), spring discs 2nd valve disc (with bore) and suction valve cap into cylinder head and tighten with socket wrench 352 589 03 07 00 and torque wrench 001 589 39 21 01.

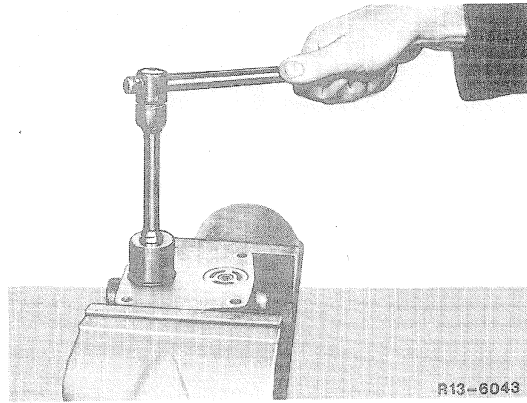

12 Compress piston rings with clamping strap 321 589 01 37 00 and pliers 321 589 00 37 00 to OD of piston. Mount cylinder liner over piston.



13 Mount cylinder head with new gasket on cylinder liner.

14 Screw cylinder head with cylinder liner to crankcase.

15 Install intake hose and pressure line.

18.11 Removal and installation of oil filter elements

OM 314

Tightening torques in Nm (kpm)

Oil filter bowl (center screw) to cylinder crankcase	60 (6)
--	--------

Special tools

Torque wrench 20–100 Nm (2–10 kpm)	000 589 64 21 00
------------------------------------	------------------

Removal

- 1 Unscrew oil drain plug on filter bowl. Drain oil.
- 2 Unscrew center screw. Remove oil filter bowl with screen jacket filter (main flow filter) and bypass cartridge.

Note: Starting engine end No. 268 866, the screen jacket filter and the bypass cartridge are replaced by a paper main flow filter element. This paper main flow filter element or up to engine end No. 268 865 the bypass cartridge must be replaced on principle during each oil change in combination with sealing ring (O-ring).

- 3 Clean screen jacket filter in clean gasoline with a soft brush.
- 4 Clean filter bowl, spring retainer and center screw.

Installation

- 1 Place screen jacket filter and new bypass cartridge or paper main flow filter element (without screen jacket filter) into filter bowl.
- 2 Insert new sealing ring (O-ring) into filter head.
- 3 Position filter bowl with filter elements concentrically against filter head. Tighten center screw.
- 4 Screw oil drain plug to filter bowl.
- 5 Add oil through oil filler hole on filter head.

Note: Prior to starting, crank engine with starter motor until oil pressure gauge indicates pressure. During this process, push stop button completely down so that engine cannot fire.



18.11 Disassembly and assembly of oil filter carrier

OM 314

Data

Spring for bypass valve in oil filter carrier

OD mm	Wire dia. mm	Set to bar (kp/cm ²)	Unloaded spring length mm	Spring preload		Spring final load	
				Length mm	Load N (kp)	Length mm	Load N (kp)
16.5	1.5	1.6–2.5 (1.6–2.5)	66	31	45±3 (4.5±0.3)	21.0	57 (5.7)

Tightening torque in Nm (kpm)

Oil filter carrier	60 (6)
--------------------	--------

Special tool

Torque wrench 20–100 Nm (2–10 kpm)	000 589 64 21 00
------------------------------------	------------------

Disassembly

- 1 Remove oil filter elements.
- 2 Unscrew oil pressure gauge transmitter from oil filter carrier.
- 3 Unscrew lube oil line.
- 4 Unscrew bypass valve for oil filter from carrier.
- 5 Unscrew oil filter carrier from cylinder crankcase and remove.
- 6 Clean all parts well, blow out with compressed air.

Assembly

- 1 Check spring of bypass valve on suitable spring testing machine and replace, if required.
- 2 Position oil filter carrier with new gasket against cylinder crankcase and screw down.
- 3 Insert bypass valve components into filter carrier and tighten closing plug.
- 4 Screw lube oil line with hollow screw to closing plug of bypass valve.
- 5 Screw oil pressure gauge transmitter to hollow screw of lube oil line.
- 6 Attach oil filter elements with filter bowl to oil filter carrier.



18.11 Removal and installation of oil pump

OM 314

Tightening torques in Nm (kpm)

Oil pump		40 (4)
Oil pan (casting)	M 6	12 (1.2)
	M 8	25 (2.5)
Oil pan (sheet metal)	M 6	8 (0.8)
	M 8	9 (0.9)

Special tools

Torque wrench 0–60 Nm (0–6 kpm)	000 589 27 21 00
---------------------------------	------------------

Removal

- 1 Drain oil.
- 2 Unscrew oil pan and remove.
- 3 Unscrew fastening screw of oil pump and remove oil pump from cylinder crankcase.

Installation

- 1 Insert oil pump into cylinder crankcase and tighten with torque wrench 000 589 27 21 00.
- 2 Attach oil pan with new gasket.
- 3 Add oil.



Disassembly and assembly of oil pump 18.11

OM 314

Data

Oil pump

Radial play of drive shaft	0,016–0,042
Radial play between oil pump gear and oil pump shaft	0,011–0,040
Overlap of oil pump shaft and body	0,010–0,039
Radial play of oil pump gears between body and gear	0,030–0,105
Axial play of oil pump gears between body cover and gear	0,025–0,089
Backlash of oil pump gears	0,15 –0,25
Backlash of oil pump drive gears (helical gears)	0,096–0,128
Number of teeth on oil pump gears	7/7
Test torque for helical gear of oil pump	7
Test torque for oil pump gear (driving)	

Dimension A	Diameter in body	17,018
		17,000
	Diameter of drive shaft	16,984
		16,976
Dimension B	Diameter of oil pump shaft	15,039
		15,028
	Body height for gear motion	39,025
		39,000
	Height of oil pump gear	39,975
		39,936
Dimension C	Installation height of oil pump shaft	34,2 + 0,3
Dimension D	Permissible play between helical drive gear and top edge of pump body, with driving gear touching upper edge of pump body	0,04
Dimension E	Installation height of drive shaft	0,5–0,8

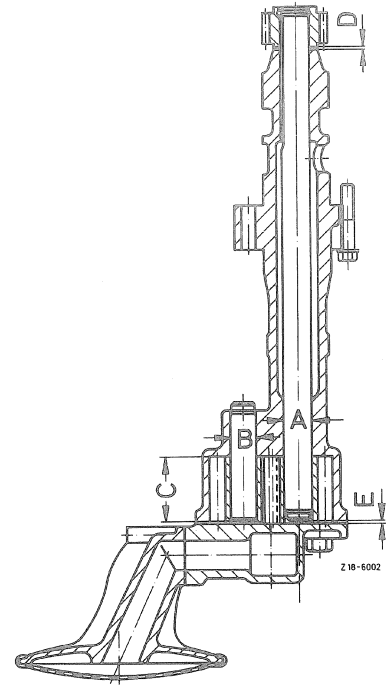

Oil pump test

Delivery, measured with SAE 10 oil; oil temperature 50° C oil backpressure 4 bar (kp/cm ²)	300 rpm	6,0 l/min
	1400 rpm	43,0 l/min
Opening pressure of relief valve	5,2 ± 0,5 bar (kp/cm ²)	

18.11 Disassembly and assembly of oil pump

Springs for oil relief valves

	OD mm	Wire gauge mm	Bar setting (kp/cm ²)	Extend- ed spring length mm	Spring preloaded		Ultimate spring tens.	
					length mm	load N (kp)	length mm	load N (kp)
In oil pump	9,3	1,7	5,2 ± 0,5	49,4	45,4	43,9 (4,39)	36,2	145 (14,5)

Tightening torques in Nm (kpm)

Cover to oil pump	35	(3,5)
Strainer basket to cover	20–25	(2–2,5)
Oil relief valve to cover	15	(1,5)

Special tools

Puller	000 589 88 33 00
--------	------------------

Disassembly

- 1 Clamp oil pump in vise, using soft jaws.
- 2 Unscrew strainer basket from cover.
- 3 Unscrew oil pump body cover.
- 4 Remove screw plug of oil relief valve and withdraw together with spring, piston and valve body.

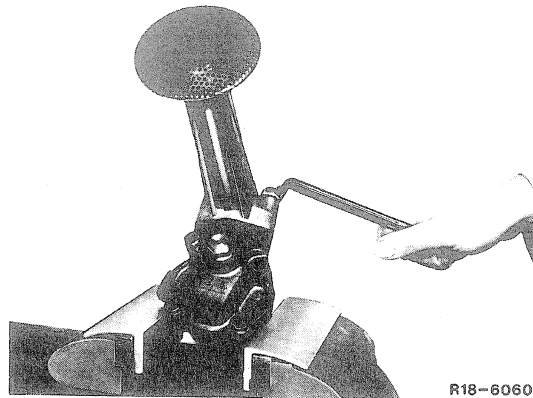

- 5 Detach helical gear, using special tool.
- 6 Take oil pump gear and drive shaft out of oil pump body.
- 7 Force oil pump gear off drive shaft.
- 8 Remove oil pump gear from oil pump shaft.
- 9 Force oil pump shaft out of body.

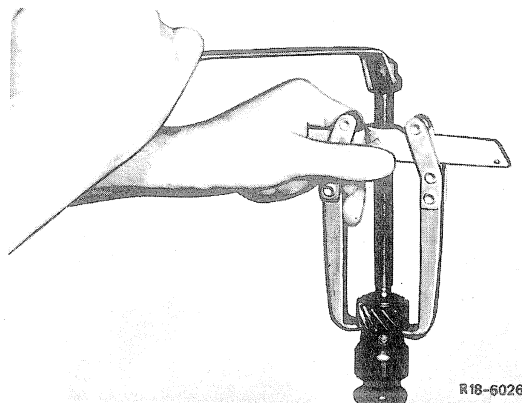

Puller 000 589 88 33 00

Assembly

- 1 Heat driving oil pump gear to approx. 80° C and fit on drive shaft.
- 2 Force oil pump shaft into body.
- 3 Introduce drive shaft and gear into body.
- 4 Check axial play of oil pump gear.
- 5 Heat helical gear to approx. 80° C and fit on drive shaft.
- 6 Check axial play of drive shaft.
- 7 Coat relief valve thread with sealant 002 939 93 71.
- 8 Insert oil relief valve into body cover and torque to 15 Nm with torque wrench.

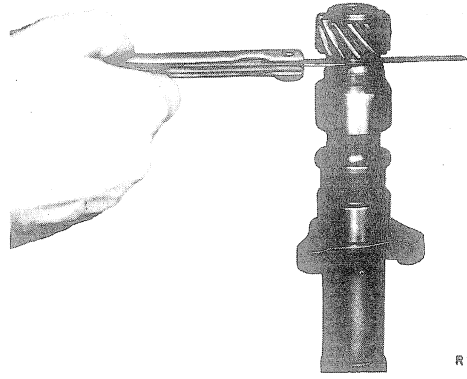

R18-6011

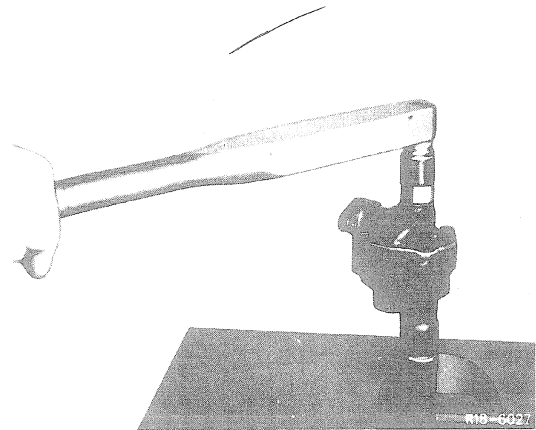

R18-6027

- 9 Bolt strainer basket to body cover.
- 10 Bolt body cover to body.

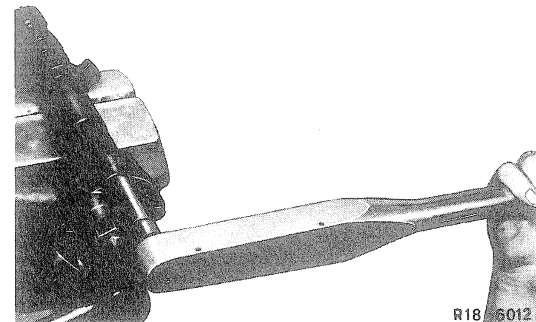

R18-6012

20.11 Exploded view

OM 314

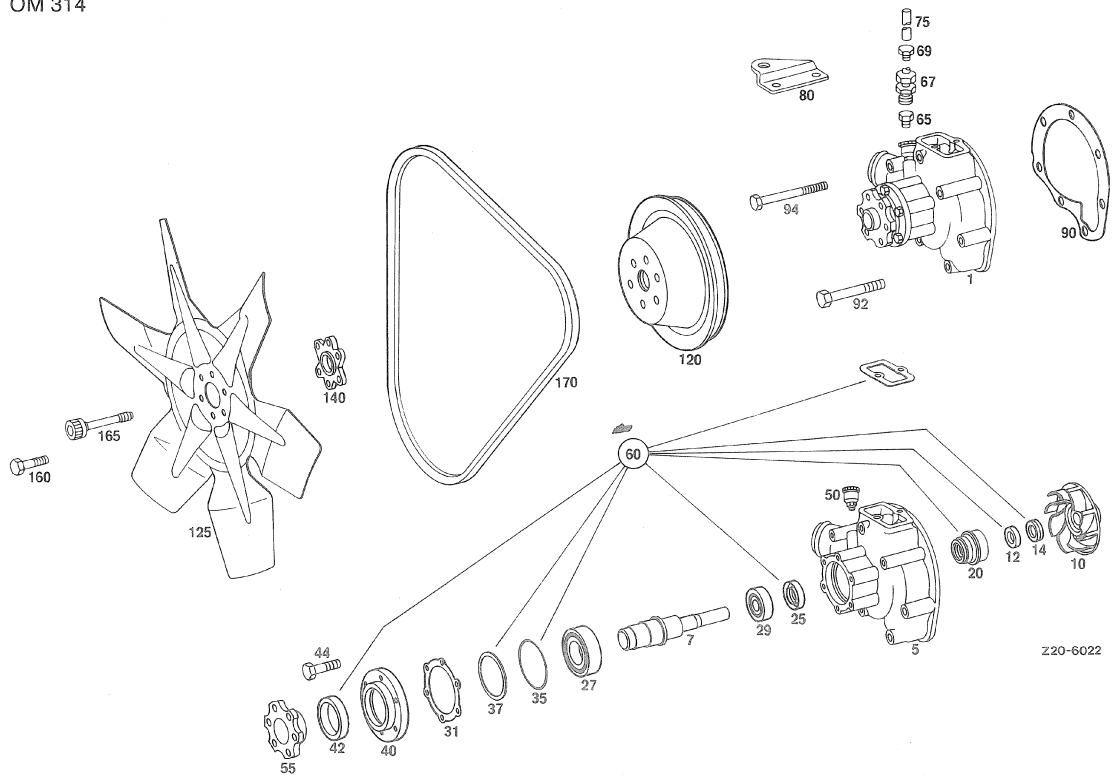

Water pump

1	Water pump	35	Sealing ring	75	Oil line
5	Housing	37	Gasket	80	Holder
7	Shaft	40	Sealing ring holder	90	Gasket
10	Impeller	42	Sealing ring	92	Screw
12	Thrust ring	44	Screw	94	Screw
14	Sleeve	50	Lube nipple	120	Pulley
20	Sealing ring	55	Flange	125	Fan
25	Sealing ring	60	Repair set	140	Hub ring
27	Radial ball bearing	65	Connection	160	Screw
29	Radial ball bearing	67	Double tapered ring	165	Screw
31	Gasket	69	Coupling screw	170	Vee-belt

20.11 Removal and installation of water pump

OM 314

Tightening torques in Nm (kpm)

	M 6	10–15 (1–1.5)
Water pump, water line, thermostat housing	M 8	30 (3)
	M 10	50 (5)
Fan to hub		30 (3)

Special tools

Torque wrench 0–60 Nm (0–6 kpm)	000 589 27 21 00
---------------------------------	------------------

Removing water pump

- 1 Drain cooling water into clean container, if mixed with antifreeze.
- 2 Loosen vee-belt by means of tensioning screw on alternator and remove.
- 3 Remove upper cooling water pipe together with thermostat housing.
- 4 Remove cooling water hose on pipe to radiator from water pump.
- 5 Unscrew fan and vee-belt pulley from water pump shaft.
- 6 Unscrew water pump from engine and remove.

Installing water pump

- 1 Screw water pump to engine with a gasket.
- 2 Mount fan and vee-belt pulley to hub of water pump shaft.
- 3 Attach cooling water hose to water pump.
- 4 Attach upper cooling water pipe with thermostat housing to engine.
- 5 Mount vee-belt and tension by means of tensioning screw on alternator.
- 6 Add cooling water.

Note: Add 1% treating compound to cooling water throughout the year, that is, also when antifreeze is used.



20.11 Disassembly and assembly of water pump

OM314

Data

	on impeller seat	15.039
		15.028
Water pump shaft dia.	large bearing	30.009
		29.996
	small bearing	17.008
		16.997
Shaft dia. for hub		29.054
		29.041
Bore dia. in hub		29.021
		29.000
Hub dia. for sealing ring front		42.000
		41.840
Shaft dia. for rear sealing ring		17.008
		16.997
Bore dia. in impeller		15.018
		15.000
Pressing impeller on water pump shaft		Flange surface – impeller flush with housing flange
Lubrication of water pump		Grease approx. 80 gr.

Note: When installing an exchange engine, make absolutely sure that the intermediate ring installed between the water pump and the fan is of the same thickness as in the removed engine. If required, replace intermediate ring since the distance of 25 to 30 mm between the radiator and the fan must be maintained.

Water pump

- a Reference dimension 119 ± 0.5
- A Water pump shaft
- B Hub
- C Holder with front oil sealing ring
- D O-ring
- E Large radial ball bearing
- F Small radial ball bearing
- G Rear oil sealing ring
- H Sliding ring seal
- J Impeller
- K Distance impeller and housing $0.6 \begin{matrix} +0.5 \\ -0.3 \end{matrix}$

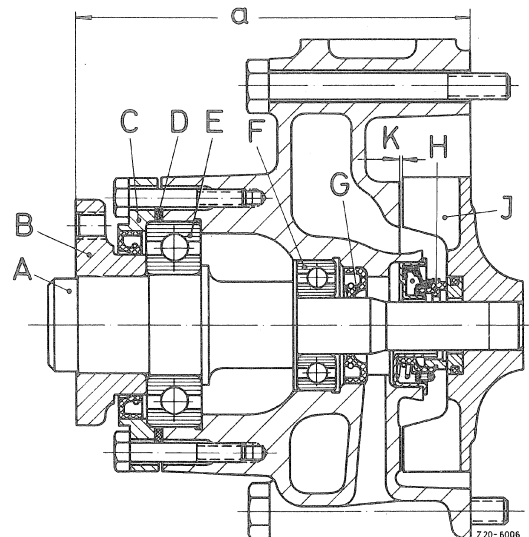

20.11

Special tools

Sleeve	312 589 01 14 00
Mandrel	321 589 00 15 00
Puller	355 589 00 33 00
Mandrel	321 589 01 35 00

Disassembling water pump

- 1 Pull hub from water pump shaft with puller 355 589 00 33 00.
- 2 Unscrew sealing ring holder and remove.
- 3 Unscrew grease cup.
- 4 Force water pump shaft with radial ball bearing out of housing from direction of impeller.
- 5 Press small radial ball bearing and radial sealing ring out of housing by means of mandrel 321 589 01 35 00.
- 6 Force slide ring seal out of housing.
- 7 Force large radial ball bearing from water pump shaft.
- 8 Remove counterring with round rubber ring or slide ring with angle sleeve out of impeller.

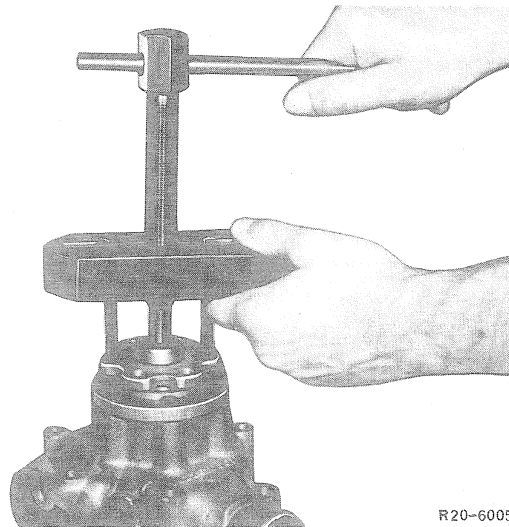

R20-6005

Assembling water pump

- 1 Press radial sealing ring into housing with mandrel 321 589 00 15 00.

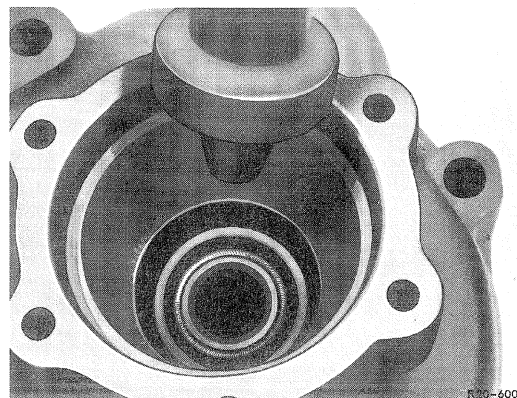

R20-6009

20.11 Disassembly and assembly of water pump

- 2 Force slide ring seal into housing.
- 3 Fill small radial ball bearing with multigrade grease and press on water pump shaft with sleeve 312 589 01 14 00.
- 4 Fill large radial ball bearing with multigrade grease and press on water pump shaft.
- 5 Slip holder with front radial sealing ring on hub. Place round rubber ring over large radial ball bearing.
- 6 Press hub on water pump shaft. Fill intermediate space of both ball bearings with grease.
- 7 Force mounted water pump shaft into housing.
- 8 Screw sealing ring holder at front to water pump housing.
- 9 Insert slide ring with angle sleeve or counterring with round rubber ring into impeller.
- 10 Press impeller on water pump shaft.

Note: Observe distance between impeller and housing.

